

AM 300 HSDIB – CF

AIRMASTER

A

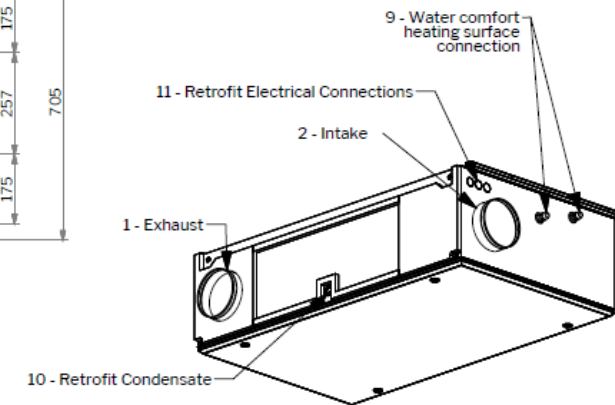
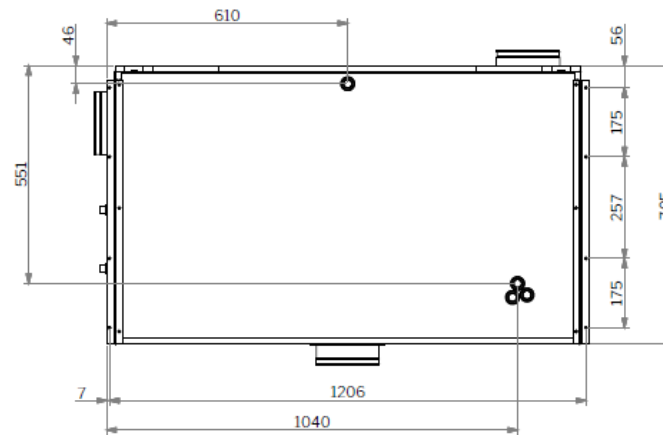
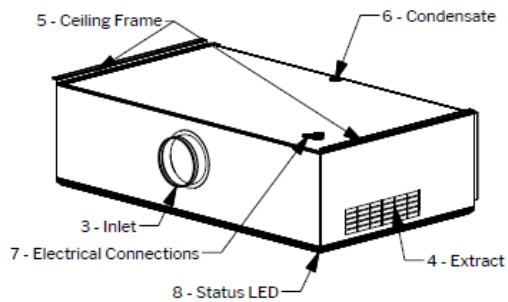
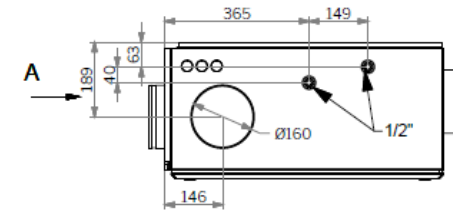
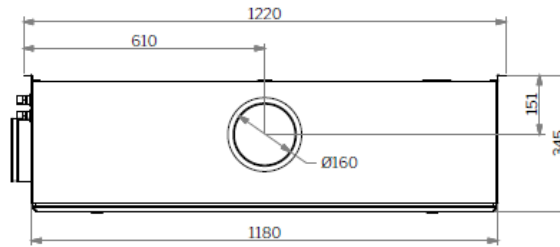
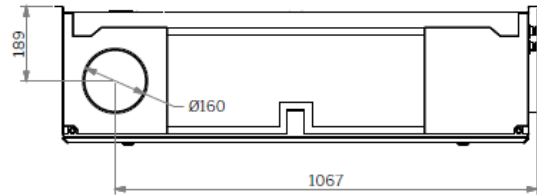
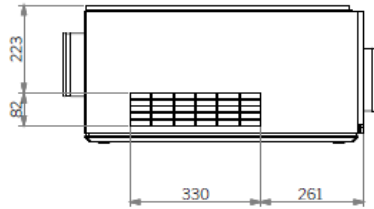

Measures in mm.

2026-01-16

DWG.:1028006

	DK	NO	SE	DE	NL	FR
1	Afkast	Avkast	Avluft	Fortluft	Afvoer	Air rejeté
2	Indtag	Inntak	Intag	Außenluft	Toevoer	Air extérieur
3	Indblæsning	Tilluft	Tilluft	Zuluft	Inblaas	Air soufflé
4	Udsugning	Avtrekk	Frånluft	Abluft	Afzuiging	Air repris
5	Vægramme	Veggramme	Väggram	Wandrahmen	Muurframe	Cadre à fixation murale
6	Kondens afløb	Kondensavløb	Kondensavlopp	Kondensatablauf	Condensafvoer	Évacuation condensats
7	EI-tilslutning	EI-tilkobling	Elektrisk anslutning	Elektrischer Anschluss	Elektrische aansluitningen	Raccordement électrique
8	LED	LED	LED	LED	LED	DEL
9	Vandeftervarme flade	Vannvarmebatteri, komfort	Vattenburet eftervarmebatteri	Wassernachheizregister	Naverwarmingsbatterij op water	Batterie à eau chaude de confort
10	Eftermontering Kondens afløb	Ettermontering Kondensavløb	Eftermontage Kondensavlopp	Nachrüstung Kondensatablauf	Achteraf te plaatsen Condensafvoer	Rééquipement Évacuation condensats
11	Eftermontering EI-tilslutning	Ettermontering EI-tilkobling	Eftermontage Elektrisk anslutning	Nachrüstung Elektrischer Anschluss	Achteraf te plaatsen Elektrische aansluitningen	Rééquipement Raccordement électrique

AIRMASTER