

Datasheet AM 500

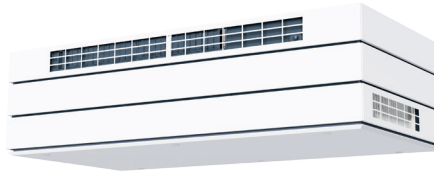

Technical data	Filter class	30 dB(A)	33 dB(A)	35 dB(A)
Maximum capacity ¹	ePM ₁₀ 50%	430 m ³ /h	490 m ³ /h	550 m ³ /h
	ePM ₁ 55%	387 m ³ /h	441 m ³ /h	495 m ³ /h
	ePM ₁ 80%	344 m ³ /h	392 m ³ /h	440 m ³ /h
Throw (0,2 m/s) ²	ePM ₁₀ 50%	5.9 m	-	7.5 m
	ePM ₁ 55%	5.4 m	-	6.7 m
	ePM ₁ 80%	4.8 m	-	6.0 m
Supply air filter	ePM ₁₀ 50%, ePM ₁ 55% or ePM ₁ 80%			
Extract air filter	ePM ₁₀ 50%			
Dimensions (BxHxD)	1600 x 439 x 779 mm			
Weight, standard air handling unit, complete	108 kg			
Color, Panel / Color, Case	RAL 9010 (white) / RAL 7024 (grey)			
Counterflow heat exchanger	Aluminum			
Air leakage classification cf. EN1886/EN13141-7	Class L2 / A2			
Air leakage classification main damper, cf. EN1751	Class 3			
IP code	10			
Duct connection	Ø250 mm			
Condensate pump (Capacity ; Lifting height at 5 l/h)	10 l/h ; 6 m			
Condensate drain hose int./ext. diameter	Ø6 mm / Ø9 mm			
Supply voltage	220-240V/50Hz, ~1N+PE			
Nominal power consumption ¹	132 W			
Nominal current ¹	1.1 A			
Power factor	0.58			
Maximum fuse	13 A (1 phase, type B). When using the cc module, it is type C			
Leakage current AC / DC	≤ 6mA			
Recommended residual current breaker (RCCB)	Type B			
Electrical heating surfaces	Preheating surface	Comfort heating surface		
Heat output	1000 W	630 W		
Nominal current	4.4 A	2.6 A		
Thermal circuit breaker, manual reset	100 °C	100 °C		
Water heating surface				
Nominal heat output ³	858 W			
Connection dimension	3/8" (DN 10)			
Materials pipes/fins	Copper/aluminum			
Opening/closing time motor valve	60 s			
Maximum operating temperature	90 °C			
Maximum operating pressure	5 bar			

¹ All measurements were performed in normal operating mode in a standard installation using the facade grilles recommended by Airmaster: Airmaster Boomerain® Ø250.

² Throw was measured with filter class: supply air ePM₁₀ 50% | Extract air ePM₁₀ 50%

³ Heat output for maximum capacity at 35 dB(A), delivery/return temperature 60/40°C and a liquid flow of 53 l/h.

Capacity with ePM₁₀ 50% / ePM₁₀ 50% filters ⁴

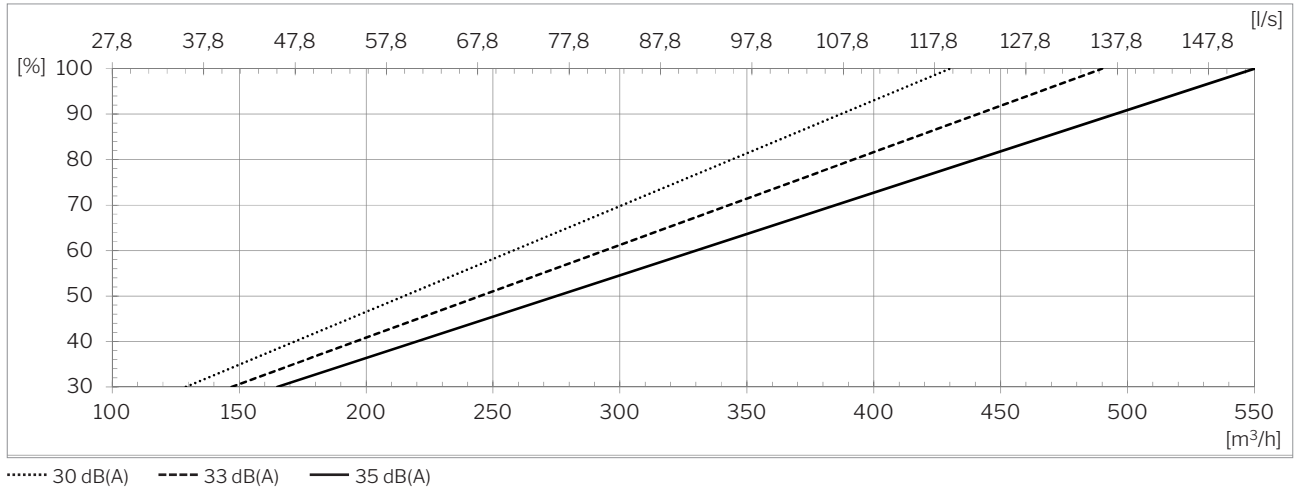

Capacity with ePM₁ 55% / ePM₁₀ 50% filters ⁴

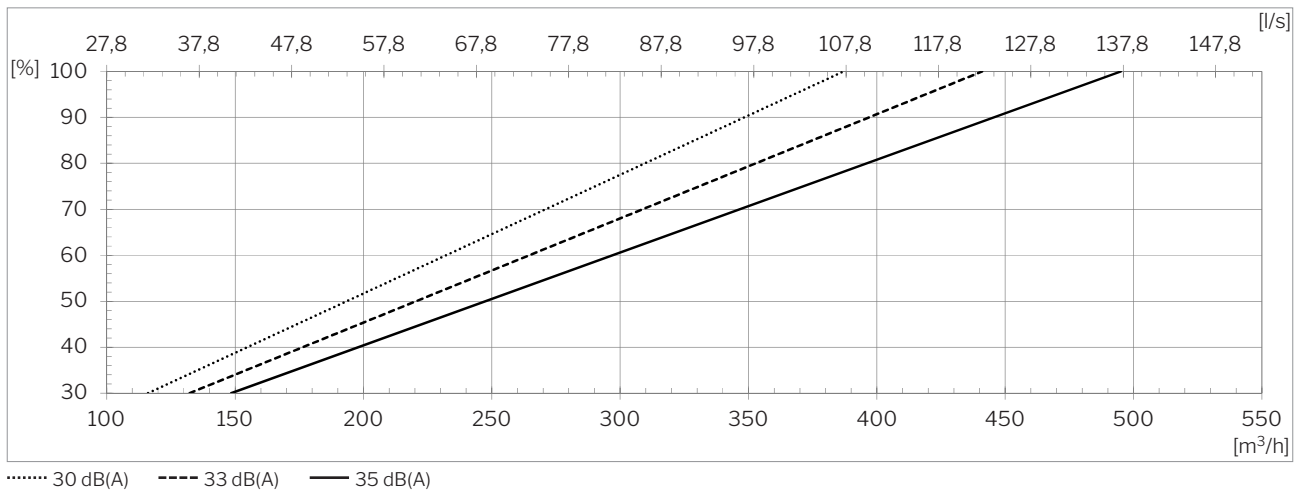

Capacity with ePM₁ 80% / ePM₁₀ 50% filters ⁴

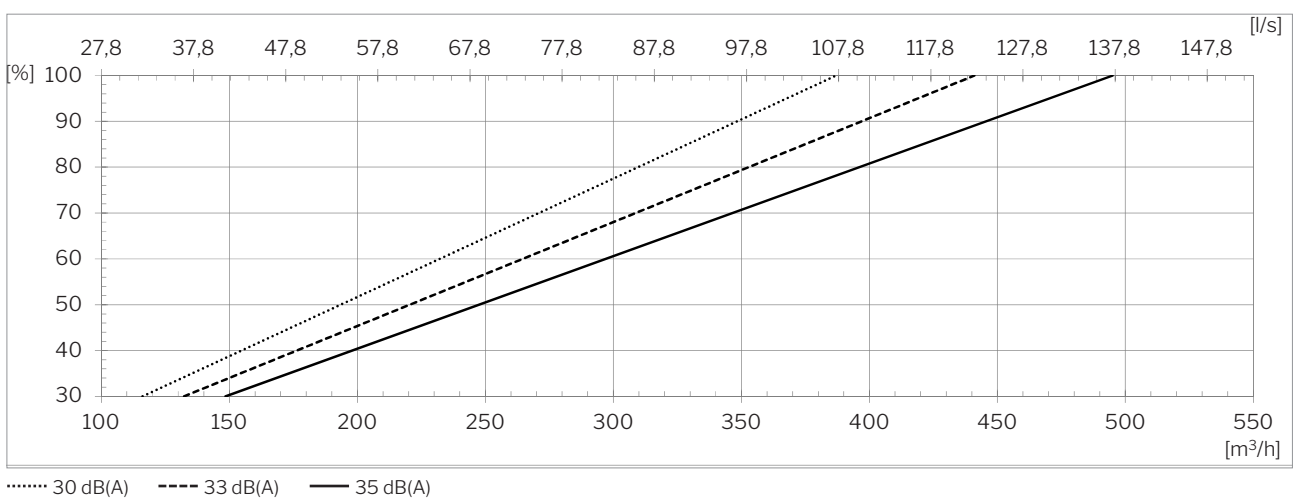

⁴ All measurements were performed in normal operating mode in a standard installation using the facade grills recommended by Airmaster: Airmaster Boomerain® Ø250.

Sound pressure ^{5,6} $L_{pA,eq}$ acc. Airmaster reference situation

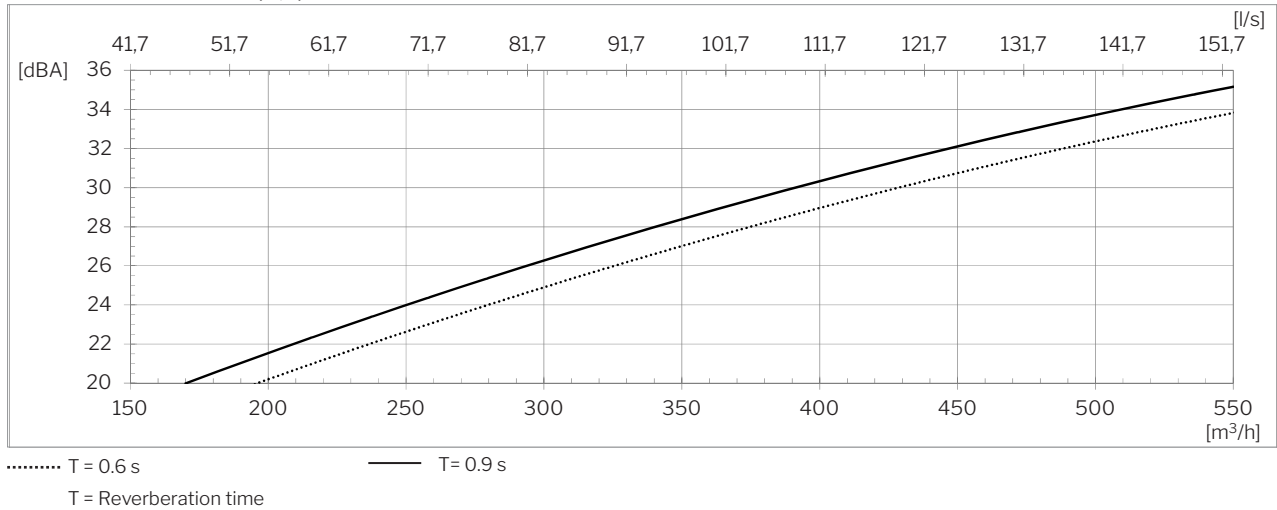

Temperature efficiency acc. EN 308

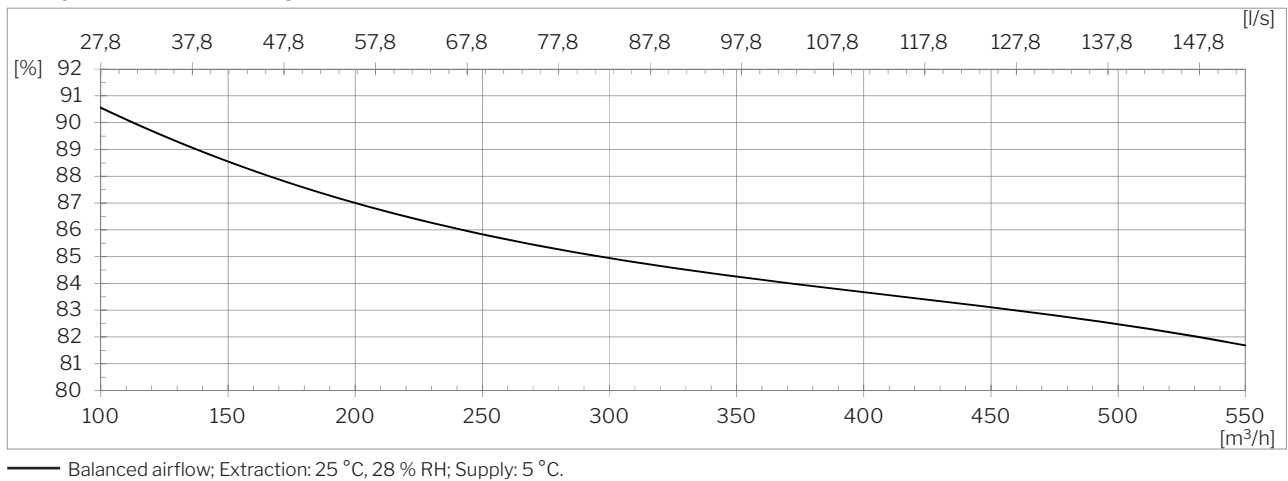

Power consumption ⁶

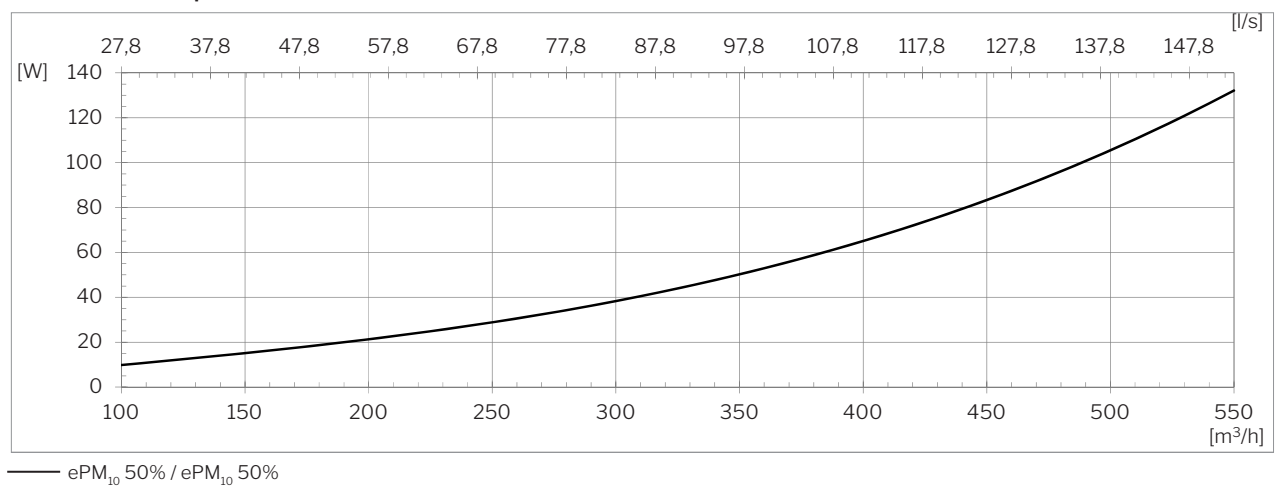

⁵ Sound pressure level $L_{pA,eq}$ is measured in a height of 1.2 m with at horizontal distance of 1 m from the air handling unit in room with a size of 200 m³ and a reverberation time of T = 0.6 s, corresponding to a room attenuation of 7.5 dB.

⁶ All measurements were performed in normal operating mode in a standard installation using the facade grills recommended by Airmaster: Airmaster Boomerain® Ø250.

SFP⁷

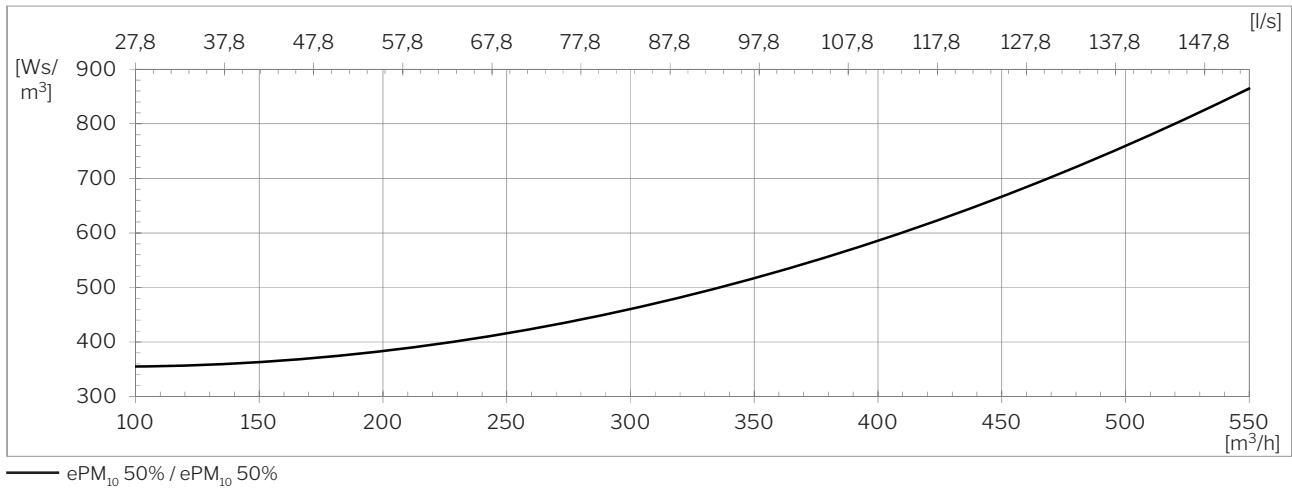

External pressure loss⁷

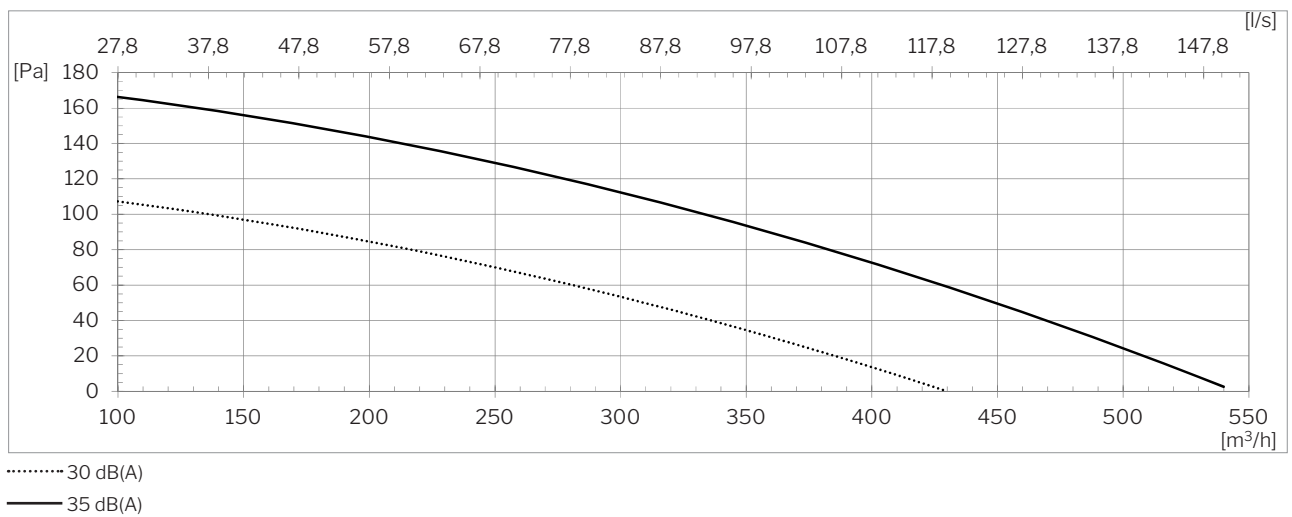

⁷ All measurements were performed in normal operating mode in a standard installation using the facade grills recommended by Airmaster: Airmaster Boomerain® Ø250.

AIRMASTER

Throw (0.2 m/s)

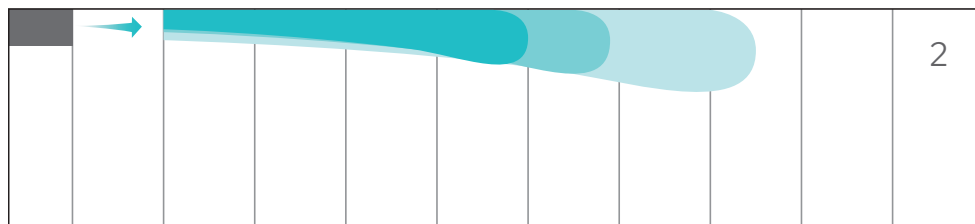
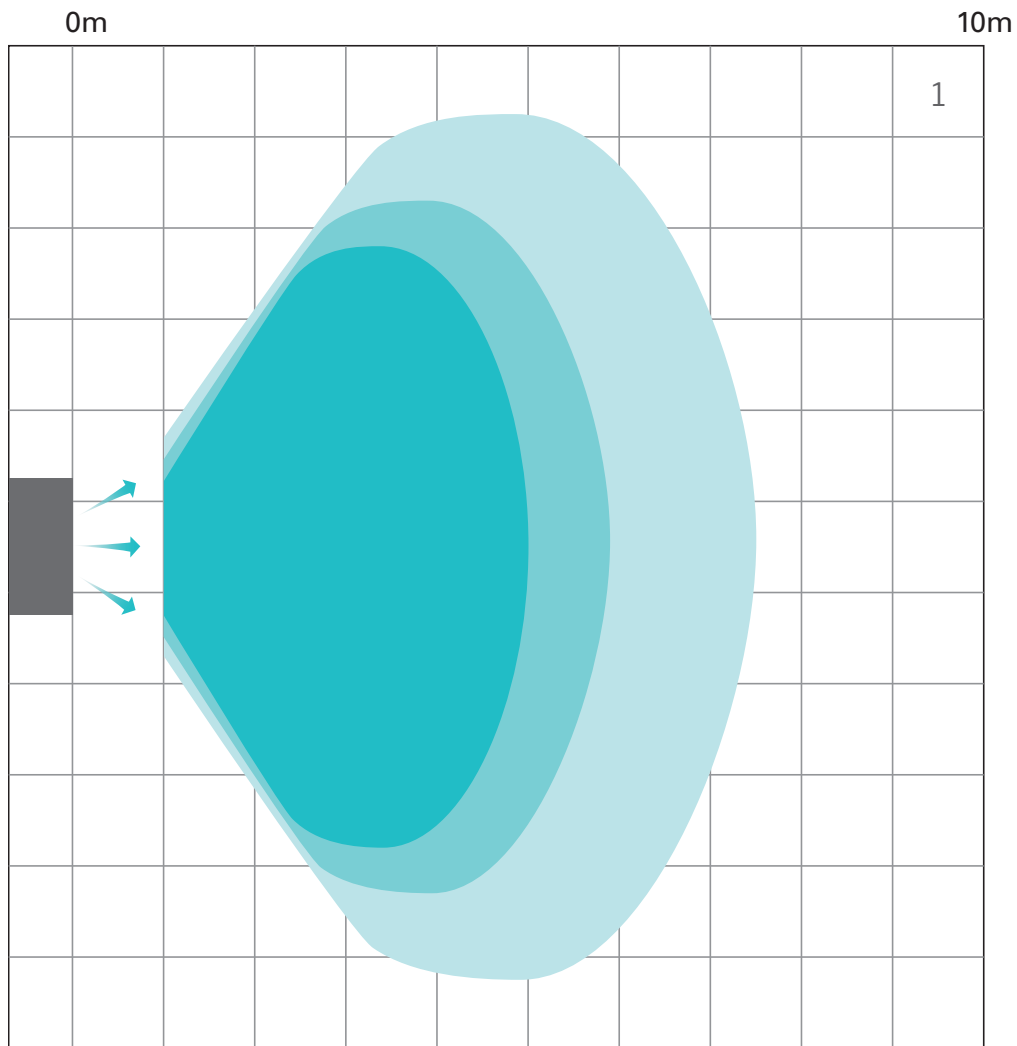

- 350m³/h
- 450m³/h
- 550m³/h

1 Throw, seen from above

2 Throw, seen from the side

AIRMASTER

Version overview

Exhaust and supply

H: Horizontal
V: Vertical
HRE: Horizontal Rectangular

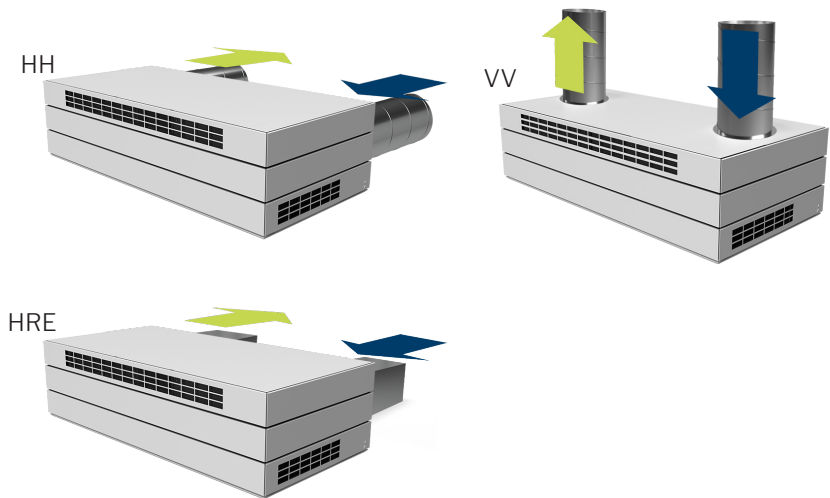

Inlet and extract

T: Top
C: Center
B: Bottom
DI: Ducted Inlet
DE: Ducted Extract

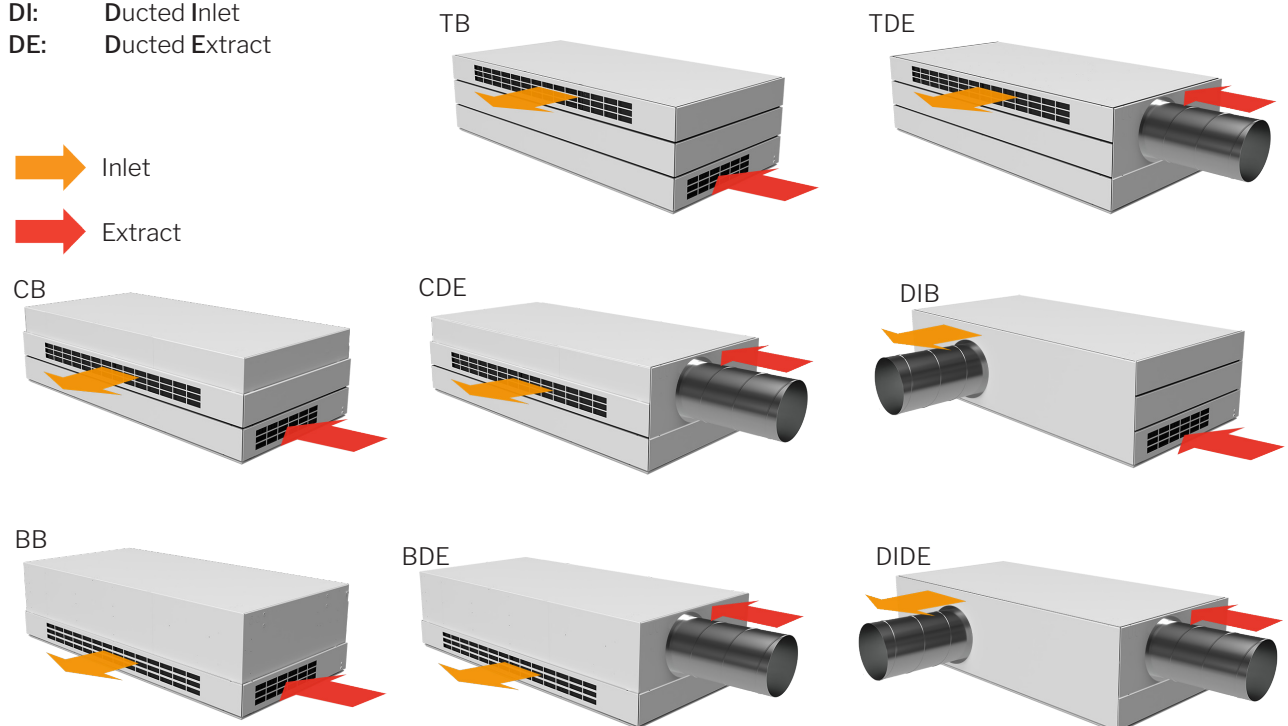

Standard and options

Counterflow heat exchanger (aluminum)	x	Energy meter	•
Enthalpy counterflow heat exchanger (Polymer membrane)	o	Cooling module, CC (Only for horizontal model)	•
Combination counterflow heat exchanger (Polymer membrane)	o	Supply air filter ePM ₁₀ 50%	•
Motor-driven bypass	x	Supply air filter ePM ₁ 55%	•
Motor-driven supply air damper	x	Supply air filter ePM ₁ 80%	o
Motor-driven extract air damper	x	Extract air filter ePM ₁₀ 50%	x
Capacitive return for motorized exhaust and supply air dampers	•	Wall-/ceiling bracket	•
Electric preheating surface	•	Ceiling frame	•
Electric comfort heating surface	•	Airlinq® Viva control panel	•
Water heating surface	•	Airlinq® Orbit control panel	•
Condensate pump	•	Airmaster Airlinq® Online	•
PIR/motion sensor (wall-mounted)	•	Airlinq® Online API	•
PIR/motion sensor (built-in)	•	Airlinq® BMS	•
CO ₂ -sensor (wall-mounted)	•	LON® module	o
CO ₂ -sensor (built-in)	•	KNX® module	o
TVOC-sensor (built-in)	•	MODBUS® RTU RS485 module	•
CO ₂ -/TVOC-sensor (built-in)	•	BACnet™ MS/TP module	•
Hygostat (wall-mounted)	o	BACnet™ /IP module	•
		Mini B USB (on front of unit)	o

X : Standard • : Optional o : Special item (not stock item)

Schematic sketch

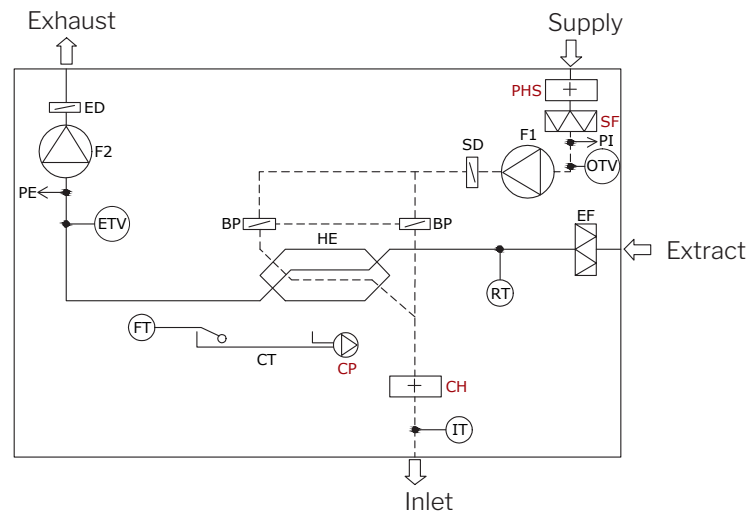

COMPONENT DESIGNATION

BP	Bypass damper (motor-driven)	EF	Extract air filter	OTV	Supply air temperature sensor
CH	Electric comfort heating surface (option)	ETV	Exhaust temperature sensor	PE	Flow meter, extracted air
CP	Condensate pump (option)	FT	Float	PHS	Preheating surface (option)
CT	Condensate tray	F1	Supply air fan	PI	Flow meter, supply air
ED	Exhaust air damper (motor-driven)	F2	Extract air fan	RT	Room temperature sensor
		HE	Counterflow heat exchanger	SD	Supply air damper (Motor-driven)
		IT	Inlet-air temperature sensor	SF	Supply air filter (option)