

Data Sheet AM 300

Technical data	Filter class	30 dB(A)	35 dB(A)	Boost
Maximum capacity ¹	ePM ₁₀ 50%	210 m ³ /h	275 m ³ /h	315 m ³ /h
	ePM ₁ 55%	205 m ³ /h	270 m ³ /h	315 m ³ /h
	ePM ₁ 80%	180 m ³ /h	240 m ³ /h	305 m ³ /h
Throw (0,2 m/s) ²	ePM ₁₀ 50%	4,25 m	6 m	7 m
	ePM ₁ 55%	4,25 m	6 m	7 m
	ePM ₁ 80%	3,5 m	5 m	6,75 m
Supply air filter	ePM ₁₀ 50%, ePM ₁ 55% or ePM ₁ 80%			
Extract air filter	ePM ₁₀ 50%			
Dimensions (WxHxD)	1180 x 344 x 705 mm			
Weight, standard air handling unit, complete	85 kg			
Weight, casing	70 kg			
Weight, service cover	15 kg			
Colour, casing	RAL 9010 (white)			
Counterflow heat exchanger	Aluminium			
Air leakage classification cf. EN1886/EN13141-7	Class L2 / A1			
Air leakage classification, main damper, cf. EN1751	Class 3			
IP code	10			
Duct connection	Ø160 mm			
Condensate pump (capacity/lifting height at 5 l/h)	10 l/h / 6 m			
Condensate drain hose int./ext. diameter	Ø4 mm / Ø6 mm			
Supply voltage	220-240V/50Hz, ~1N+PE			
Maximum power consumption ¹	204 W			
Maximum current ¹	1,87 A			
Power factor	0,48			
Maximum fuse	13 A (1 phase, type B)			
Leakage current AC / DC	≤ 0,7 mA / ≤ 0,005 mA			
Recommended residual current circuit breaker (RCCB)	Type F / Type B			
Electrical heating surfaces	Preheating surface	Comfort heating surface		
Heat output	1000 W	500 W		
Nominal current	4,35 A	2,17 A		
Thermal circuit breaker, manual reset	100 °C	100 °C		
Water heating surface				
Nominal heat output ³	1593 W			
Connection dimension	1/2" (DN 15)			
Materials pipes/fins	copper/aluminium			
Opening/closing time, motor valve	60 s			
Maximum operating temperature	90 °C			
Maximum operating pressure	5 bar			

¹ All measurements were performed in normal operating mode in a standard installation using the facade grills recommended by Airmaster: Airmaster Boomerain® Ø160, in a test room dimensioned 8.0 m x 10.0 m x 2.5 m with room attenuation of 7.5 dB.

² The throw is measured with a 2 °C subcooled supply air at the standard setting of the inlet diffuser. The setting is adaptable, see page 6.

³ Heat output for maximum capacity at 35 dB(A), delivery/return temperature 60/40 °C and a liquid flow of 87 l/h.ww

Capacity with ePM₁₀ 50% / ePM₁₀ 50% filters ⁴

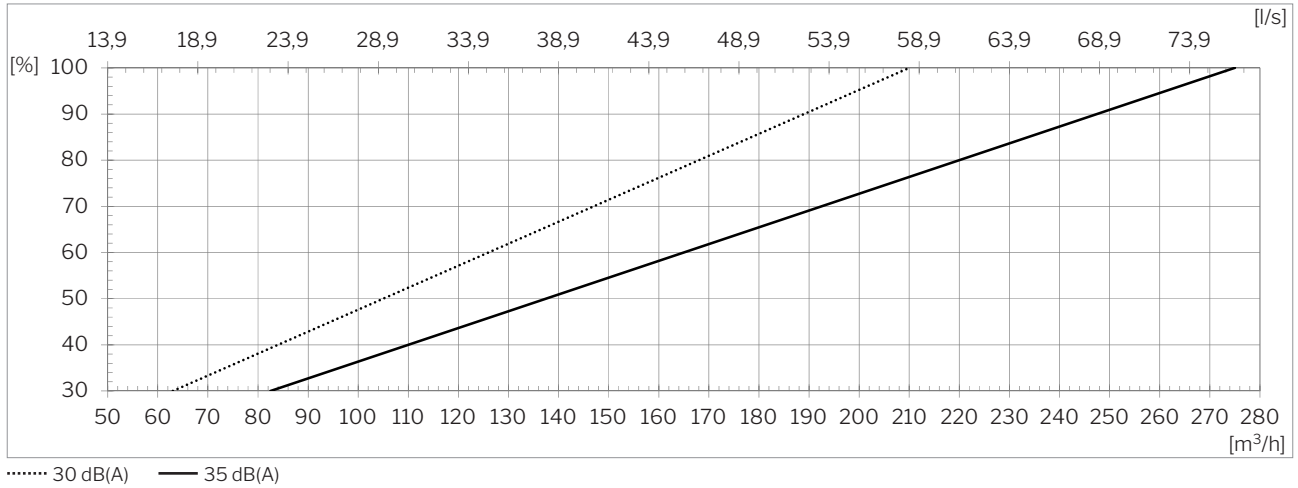

Capacity with ePM₁ 55% / ePM₁₀ 50% filters ⁴

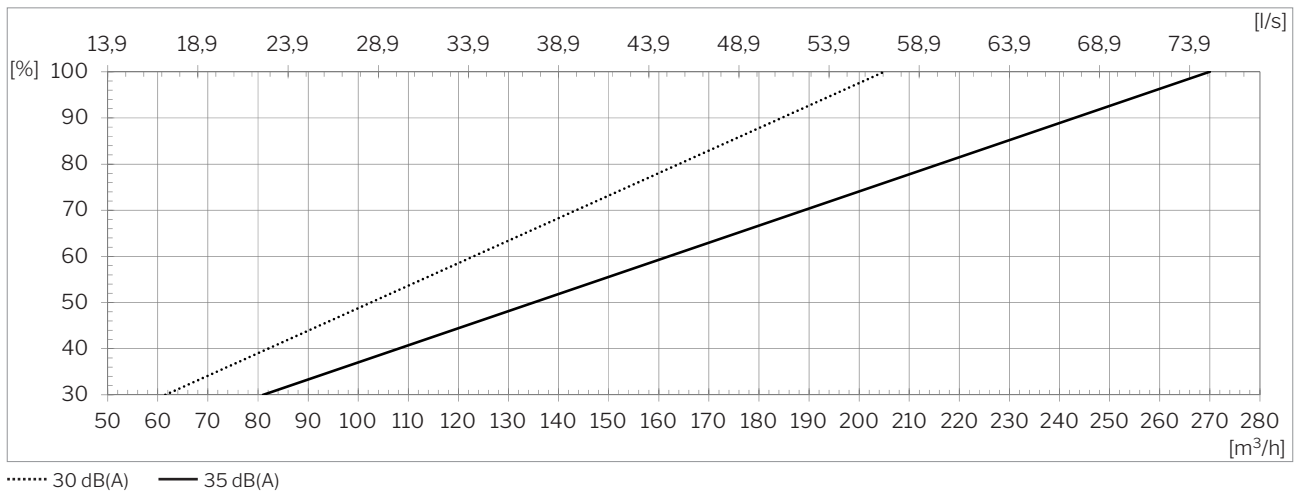

Capacity with ePM₁ 80% / ePM₁₀ 50% filters ⁴

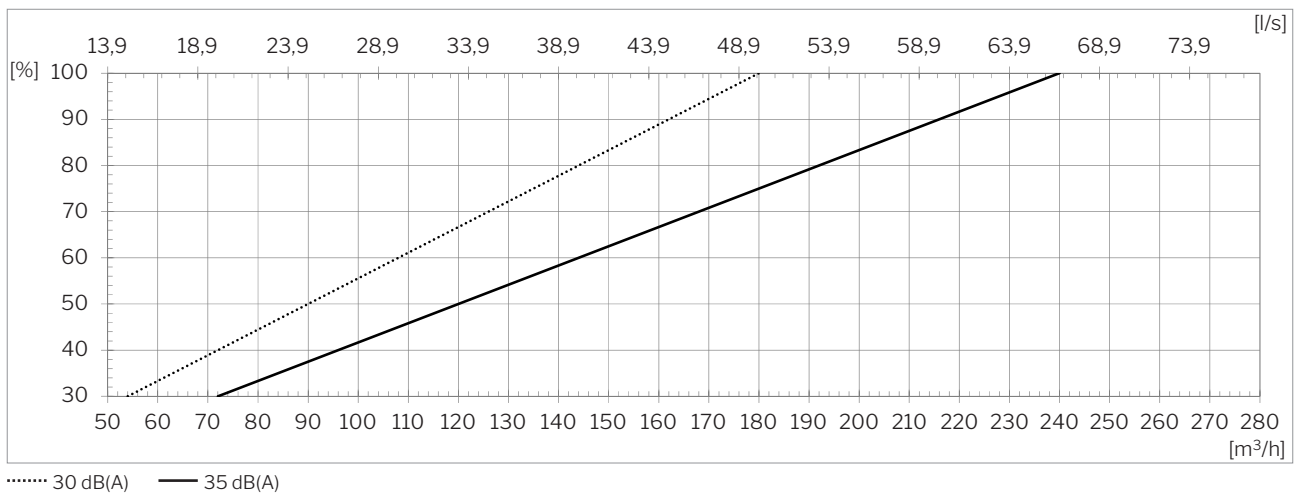

⁴ AM 300 HH, SS and variants of this, including DI and DE variants.
 Calculate air flow for AM 300 VV variants as follows
 $q_{VV, @30dB(A)} = 0,928 \cdot q_v$ or $q_{VV, @35dB(A)} = 0,928 \cdot q_v$; q_v = air flow from graph in [m³/h].

SFP with ePM₁₀ 50% / ePM₁₀ 50% filters

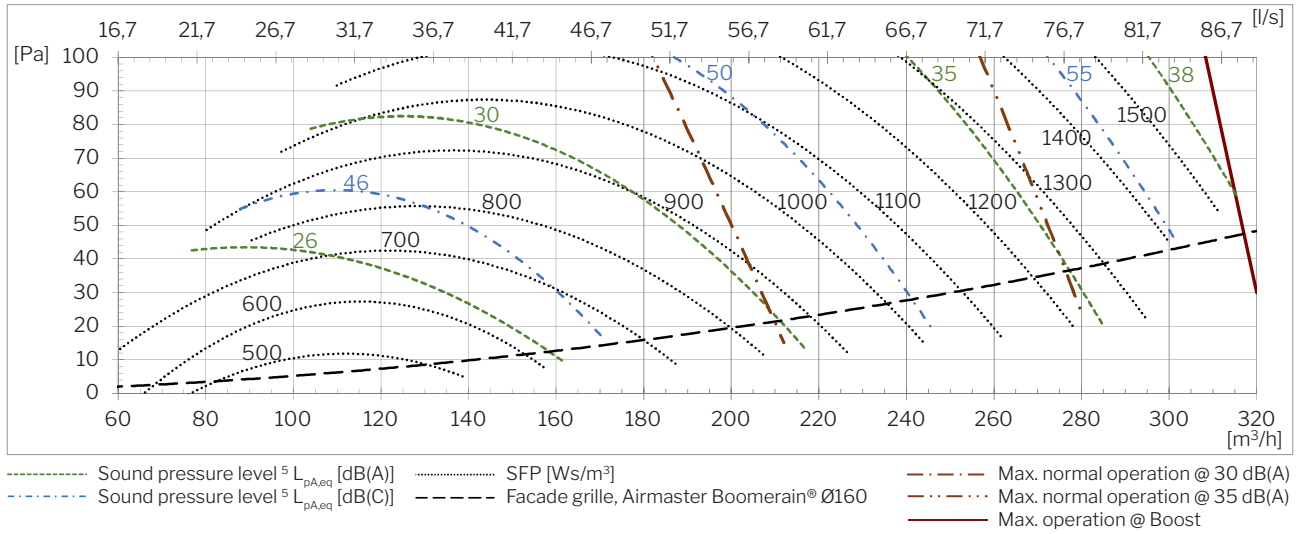

SFP with ePM₁ 55% / ePM₁₀ 50% filters

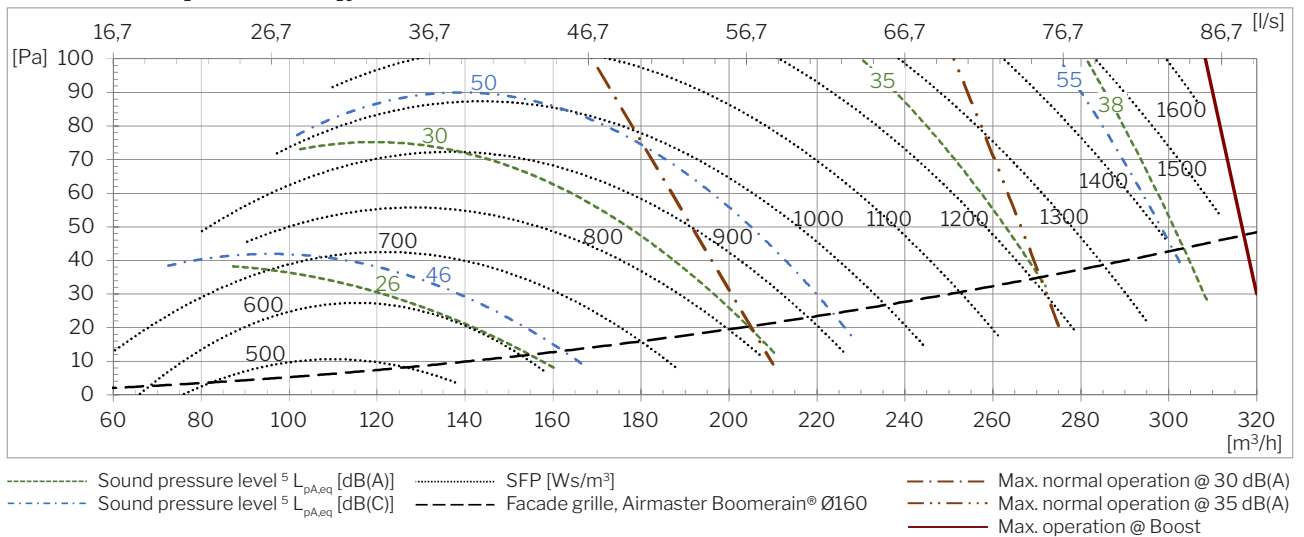

⁵ The sound pressure level L_{pA,eq} is measured at a height of 1,2 m at a horizontal distance of 1 m from the air handling unit.

Sound pressure level ^{6,7} $L_{pA,eq}$ acc. to Airmaster reference situation

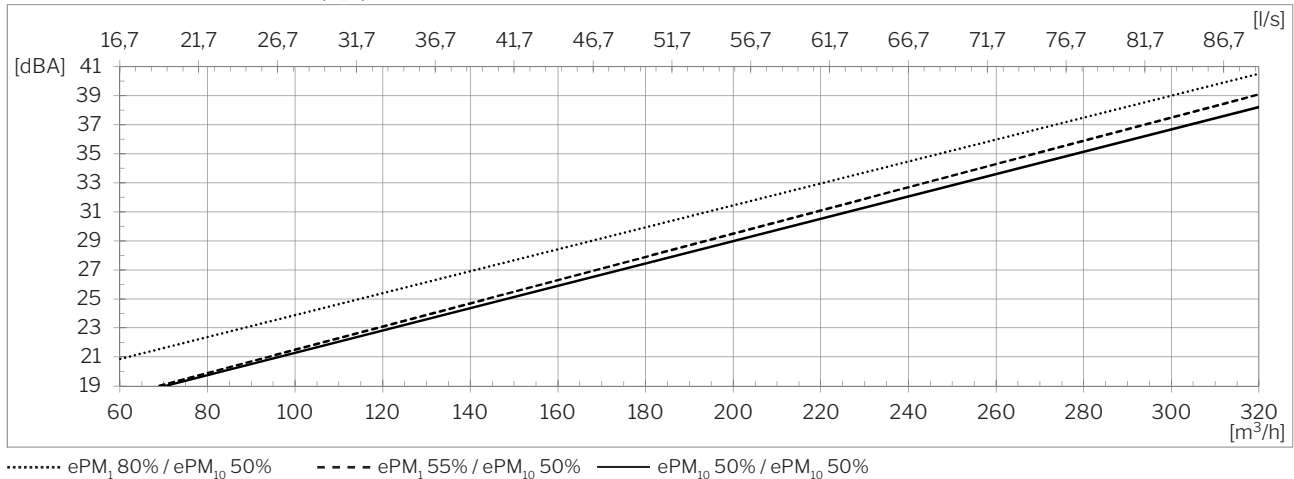

For AM 300 VV variants, add a sound pressure of $\Delta L_p = 0.00965 \cdot qv - 0.4$ to the sound pressure $L_{pA,eq}$ from the graph (qv: Air flow, [m³/h]).

Temperature efficiency acc. to EN 308 and EN 13141-7

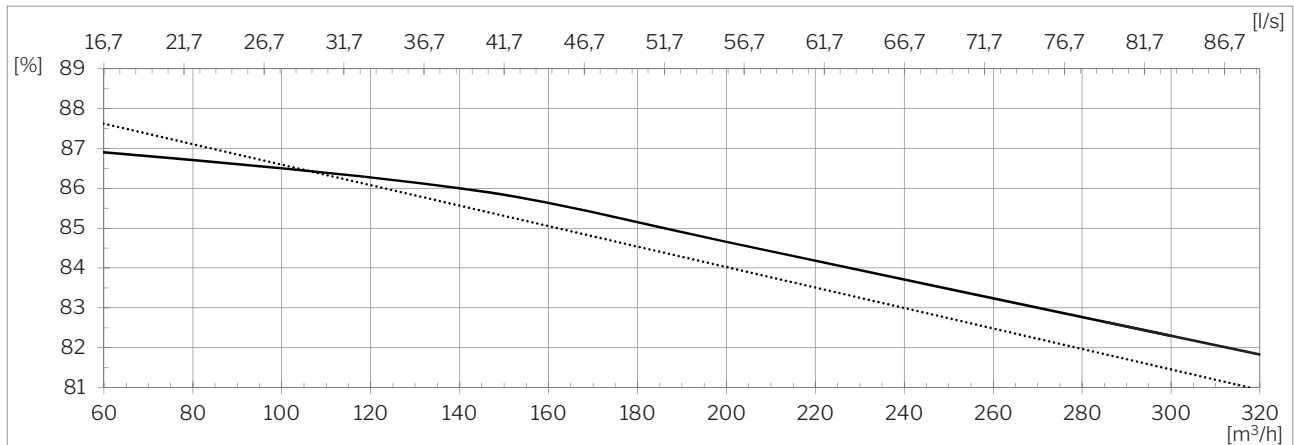

Power consumption ⁷

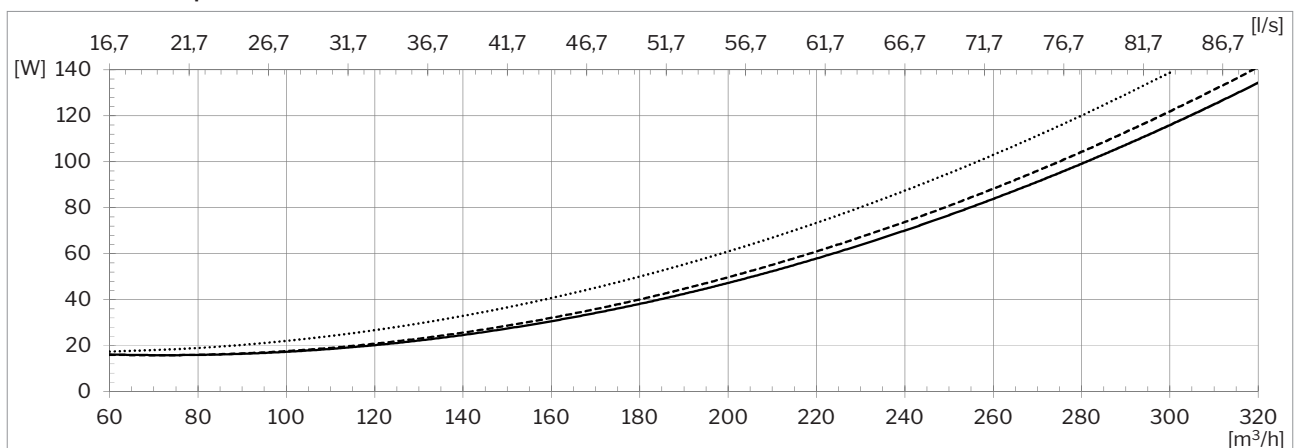

..... For AM 300 VV variants, calculate $P_{VV, ePM1 80\%} = 1,07 \cdot P$; P = power consumption in [W].
 - - - For AM 300 VV models, calculate $P_{VV, ePM1 55\%} = 1,09 \cdot P$; P = power consumption in [W].
 — For AM 300 VV variants, calculate $P_{VV, ePM10 50\%} = 1,12 \cdot P$; P = power consumption in [W].

⁶ The sound pressure level $L_{pA,eq}$ is measured at a height of 1.2 m at a horizontal distance of 1 m from the air handling unit.

⁷ AM 300 HH, SS and variants of this, including DI and DE variants.

SFP⁸

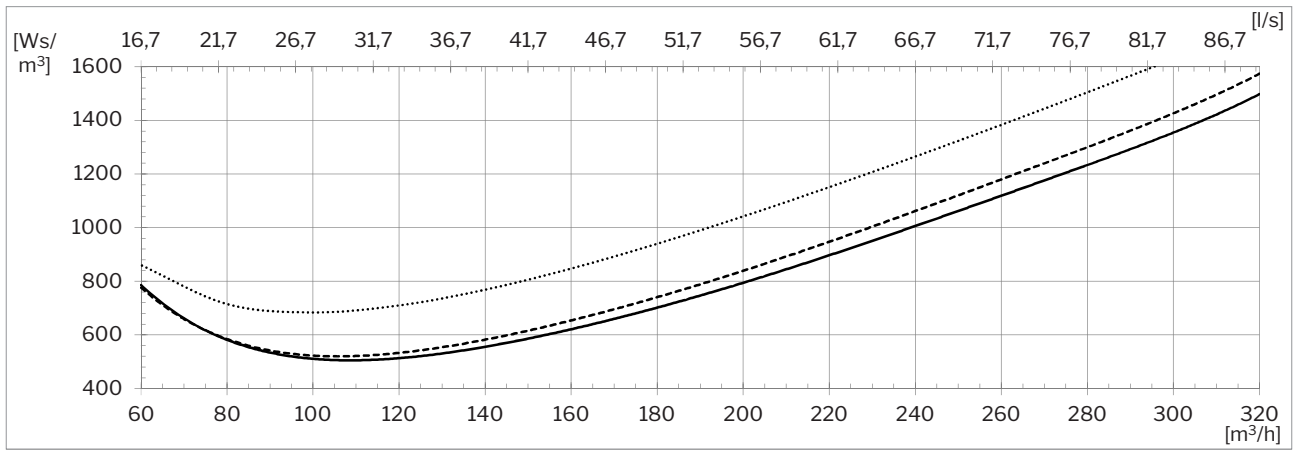

- ePM₁ 80% / ePM₁₀ 50% For AM 300 VV variants, calculate $SFP_{VV, ePM1 80\%} = 1,07 * SFP ; SFP i [Ws/m^3]$.
- - - ePM₁ 55% / ePM₁₀ 50% For AM 300 VV variants, calculate $SFP_{VV, ePM1 55\%} = 1,09 * SFP ; SFP i [Ws/m^3]$.
- ePM₁₀ 50% / ePM₁₀ 50% For AM 300 VV variants, calculate $SFP_{VV, ePM10 50\%} = 1,12 * SFP ; SFP i [Ws/m^3]$.

⁸ AM 300 HH, SS and variants of this, including DI and DE variants.

The calculation of SFP includes the power consumption for operating fans but not for controls, display panel, etc.

Throw⁹ (0,2 m/s)

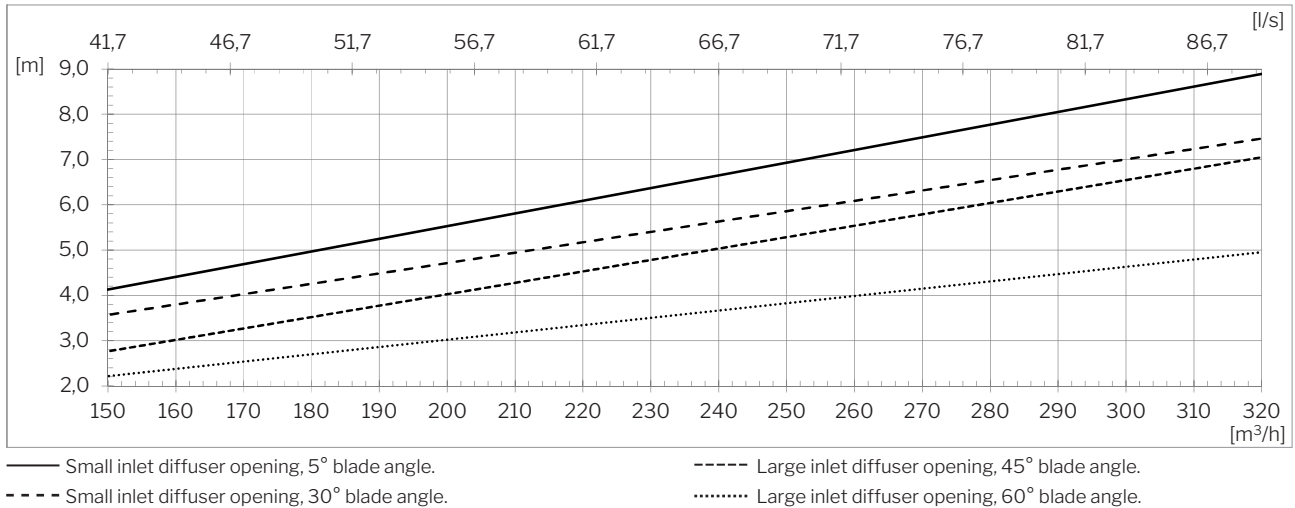

Small and large inlet diffuser opening

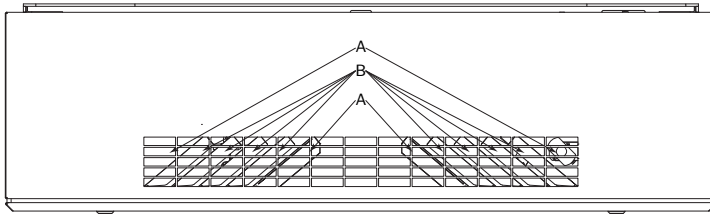

Small inlet diffuser opening:
A is closed, B is open at x° .

Large inlet diffuser opening:
A and B are open at x° .

Default delivery state:
Large inlet diffuser opening, 45° blade angle.

Throw and dispersion, top view.

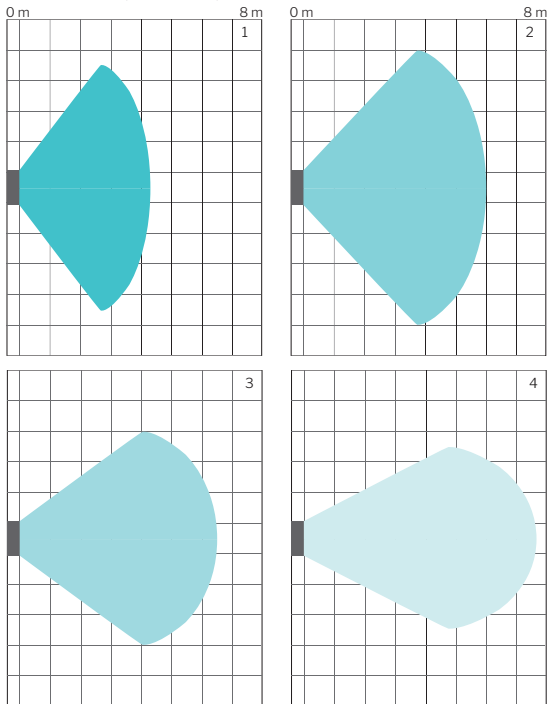

The air handling unit disperses inlet air depending on the blade angle settings.

The illustrations show the dispersion pattern and throw for the various blade angle settings at an air flow of 275 m³/h:

1. Large inlet diffuser opening, 60° blade angle.
2. Large inlet diffuser opening, 45° blade angle.
3. Small inlet diffuser opening, 30° blade angle.
4. Small inlet diffuser opening, 25° blade angle.

Changing the air flow also affects the throw length.

Throw, side view.

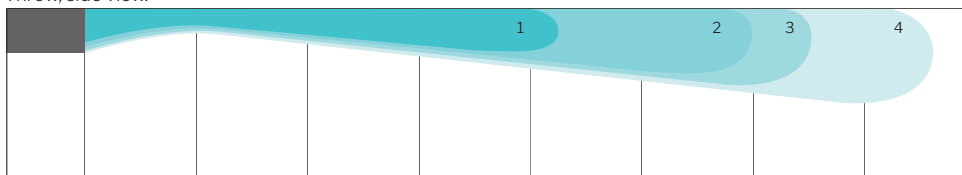

⁹ The throw is measured with a 2 °C subcooled inlet air supply.

AIRMASTER

Version overview

Exhaust/supply position

- » Back (**H**orizontal)
- » Top (**V**ertical)
- » Side (**S**ide)
- » Combinations

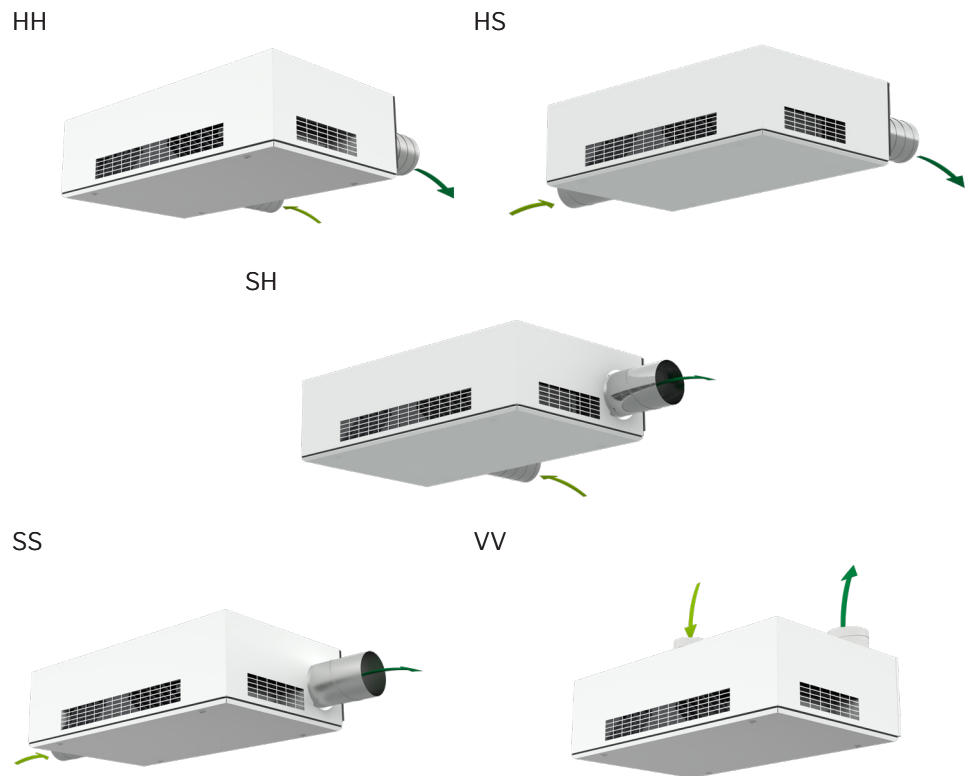

Inlet/extract position

- » Bottom (**B**)
- » Ducted Inlet (**DI**)
- » Ducted Extract (**DE**)

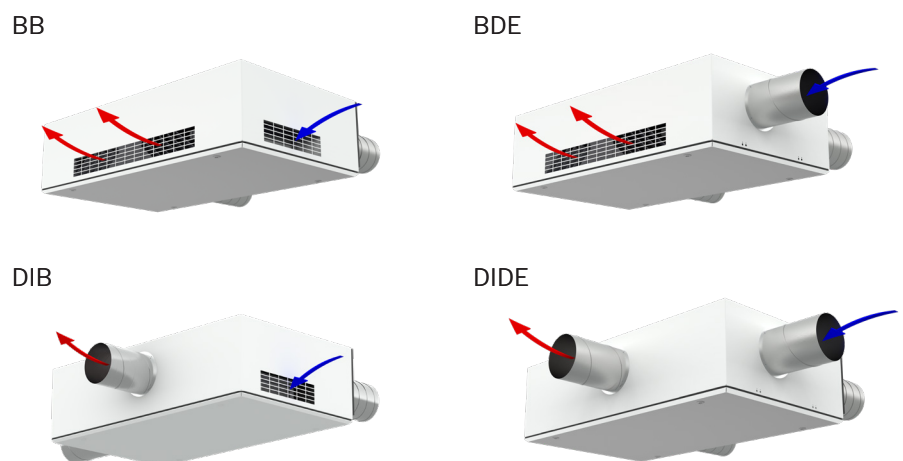

Standards and options

Counterflow heat exchanger (aluminium)	x
Enthalpy counterflow heat exchanger (polymer membrane)	o
Combination counterflow heat exchanger (polymer membrane)	o
Motor-driven bypass	x
Motor-driven supply air damper	x
Motor-driven extract air damper	x
Electric preheating surface	•
Electric comfort heating surface	•
Water heating surface	•
Condensate pump	•
Service power switch	•
Electronic humidity sensor (built-in)	•
PIR/motion sensor (wall mounted)	•
PIR/motion sensor (integrated)	•
CO ₂ sensor (wall mounted)	•
CO ₂ sensor (integrated)	•
TVOC (integrated)	•
CO ₂ -/TVOC sensor (integrated)	•
Humidity sensor (integrated)	o

X : Standard • : Optional o : Special item (not stock item)

Hygostat (wall mounted)	o
Energy meter	•
Pressure tap	•
Supply air filter ePM ₁₀ 50%	•
Supply air filter ePM ₁ 55%	•
Supply air filter ePM ₁ 80%	o
Extract air filter ePM ₁₀ 50%	x
LED (operating mode indicator)	x
Wall/ceiling bracket	•
Ceiling frame	•
Operating button	•
Control panel, Viva	•
Control panel, Orbit	•
Airmaster Airlinq® Online	•
Airlinq® Online API	•
Airlinq® BMS	•
LON® module	o
KNX® module	o
MODBUS® RTU RS485 module	•
BACnet™ MS/TP module	•
BACnet™ /IP module	•

Schematic sketch

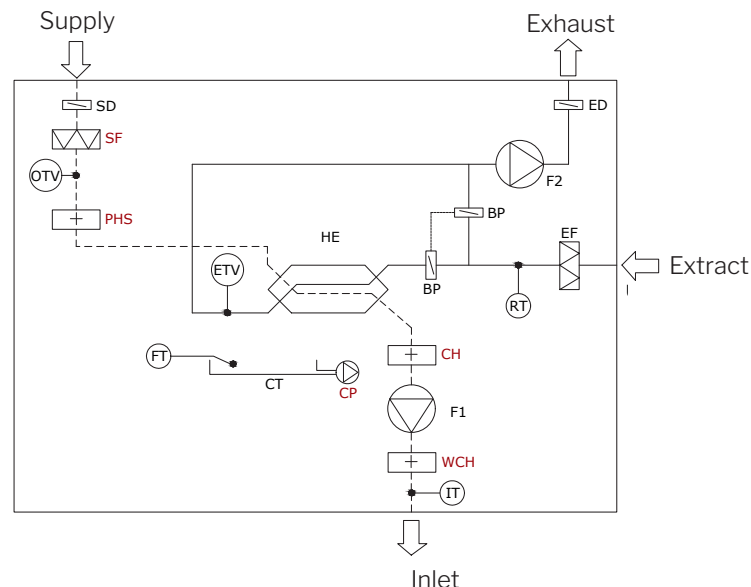

Component designation

BP	Bypass damper (motor-driven)	ETV	Exhaust temperature sensor, ventilation	OTV	Supply air temperature sensor, ventilation
CH	Electric comfort heating surface (option)	FT	Float	PHS	Electric preheating surface (option)
CP	Condensate pump (option)	F1	Supply air fan	RT	Room temperature sensor
CT	Condensate tray	F2	Extract air fan	SD	Supply air damper (motor-driven)
ED	Exhaust air damper (motor-driven)	HE	Counterflow heat exchanger	SF	Supply air filter (option)
EF	Extract air filter	IT	Inlet-air temperature sensor	WCH	Water heating surface (option)