

Data Sheet AM 150

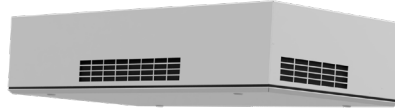

Technical data	Filter class	30 dB(A)	35 dB(A)	Boost
Maximum capacity ¹	ePM ₁₀ 50%	115 m ³ /h	147 m ³ /h	216 m ³ /h
	ePM ₁ 55%	90 m ³ /h	126 m ³ /h	197 m ³ /h
	ePM ₁ 80%	85 m ³ /h	115 m ³ /h	180 m ³ /h
Throw (0,2 m/s) ²	ePM ₁₀ 50%	2,6 m	3,4 m	4,6 m
	ePM ₁ 55%	2,1 m	2,8 m	4,2 m
	ePM ₁ 80%	1,9 m	2,6 m	3,8 m
Supply air filter	ePM ₁₀ 50%, ePM ₁ 55% or ePM ₁ 80%			
Extract air filter	ePM ₁₀ 50%			
Dimensions (WxHxD)	1170 x 261 x 572 mm			
Weight, standard air handling unit, complete	53 kg			
Weight, casing	40 kg			
Weight, service cover	13 kg			
Colour, casing	RAL 9010 (white)			
Counterflow heat exchanger	PET (Polyethylene terephthalate)			
Energy class, cf. EU regulation no. 1254	SEC class A			
Air leakage classification cf. EN1886/EN13141-7	Class L1 / Class A1			
Air leakage classification, main damper, cf. EN1751	Class 3			
IP code	10			
Duct connection	Ø125 mm			
Condensate pump (capacity/lifting height at 5 l/h)	10 l/h / 6 m			
Condensate drain hose int./ext. diameter	Ø4 mm / Ø6 mm			
Supply voltage	220-240V/50Hz, ~1N+PE			
Maximum ; nominal power consumption at 30 dB(A) / 35 dB(A) / Boost ¹	185 W ; 21 W / 38 W / 96 W			
Maximum ; nominal current at 30 dB(A) / 35 dB(A) / Boost ¹	1,35 A ; 0,2 A / 0,3 A / 0,8 A			
Recommended fuse	0,59			
Maximum fuse	13 A (1 phase, type B). When using the cc module, it is type C			
Leakage current AC / DC	≤ 0,52 mA / ≤ 0,0007 mA			
Recommended residual current circuit breaker (RCCB)	Type B			
Electrical heating surfaces				
Heat output	500 W		1000 W ³	
Nominal current	2,17 A		4,35 A	
Thermal circuit breaker, manual reset	100 °C		100 °C	

¹ All measurements were performed in normal operating mode in a standard installation using the facade grilles recommended by Airmaster, in a test room dimensioned 8.0 m x 10.0 m x 2.5 m with room attenuation of 7.5 dB. For small spaces, e.g. 4.0 m x 4.0 m x 2.5 m, 2 dB sound pressure must be added.

² The throw is measured with a 2 °C subcooled supply air at the standard setting of the inlet diffuser. The setting is adaptable, see page 6.

³ Special item.

Capacity with ePM₁₀ 50% / ePM₁₀ 50% filters

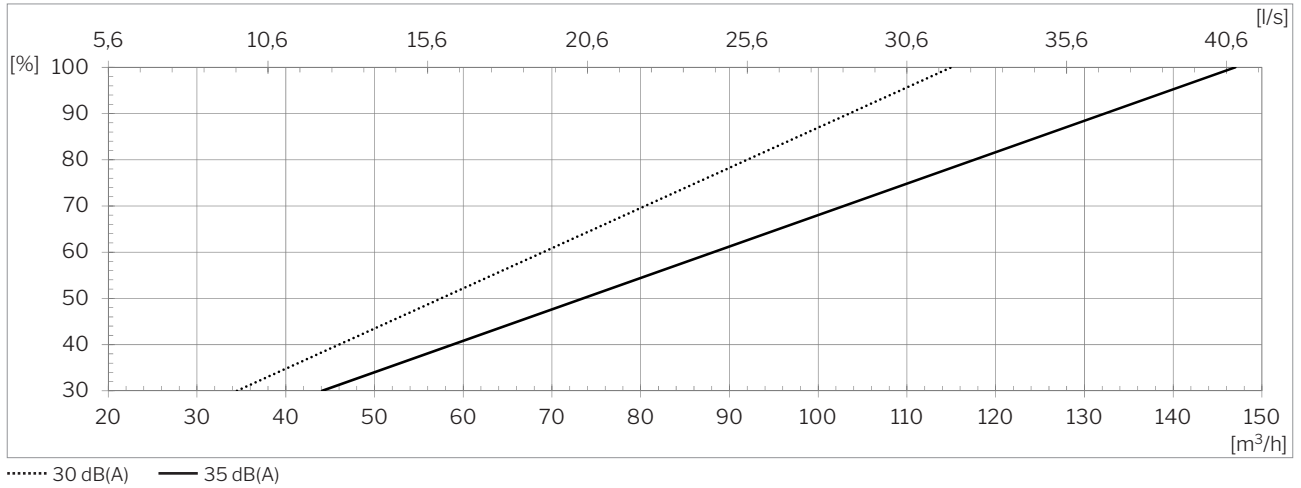

Capacity with ePM₁ 55% / ePM₁₀ 50% filters

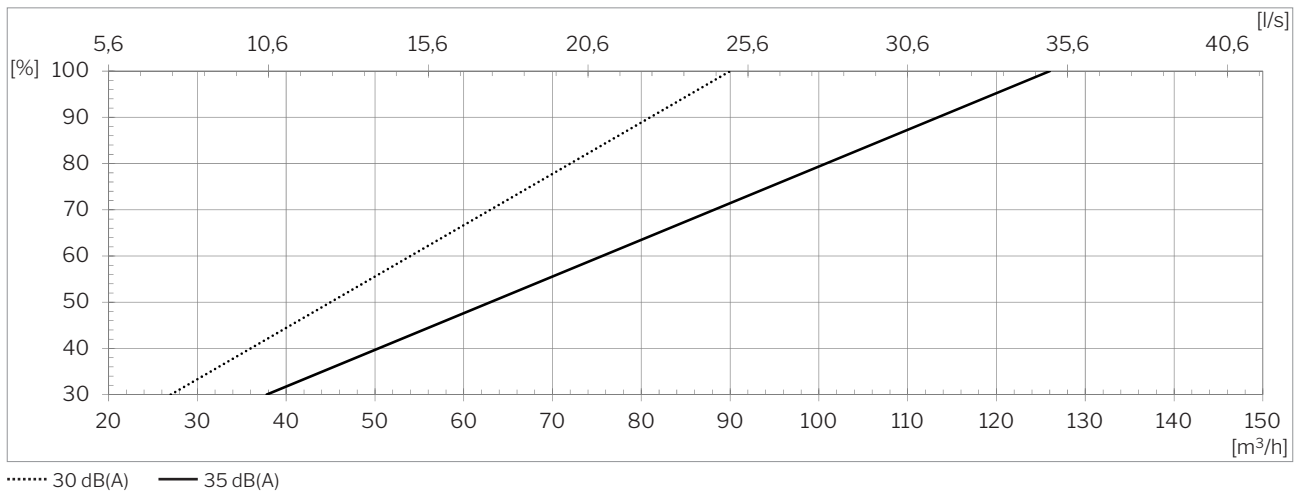

Capacity with ePM₁ 80% / ePM₁₀ 50% filters

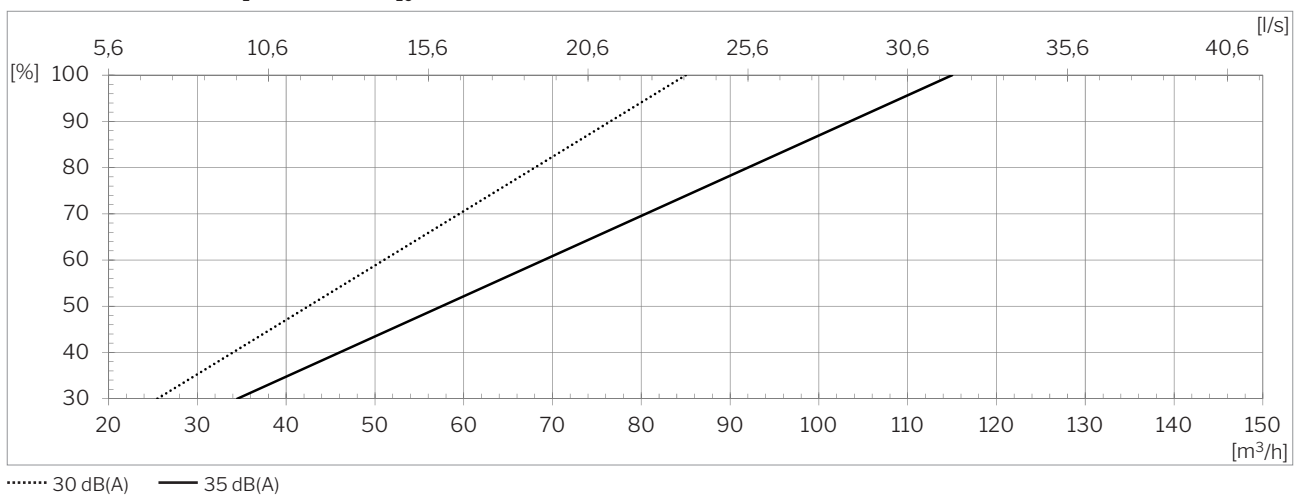

SFP with ePM₁₀ 50% / ePM₁₀ 50% filters

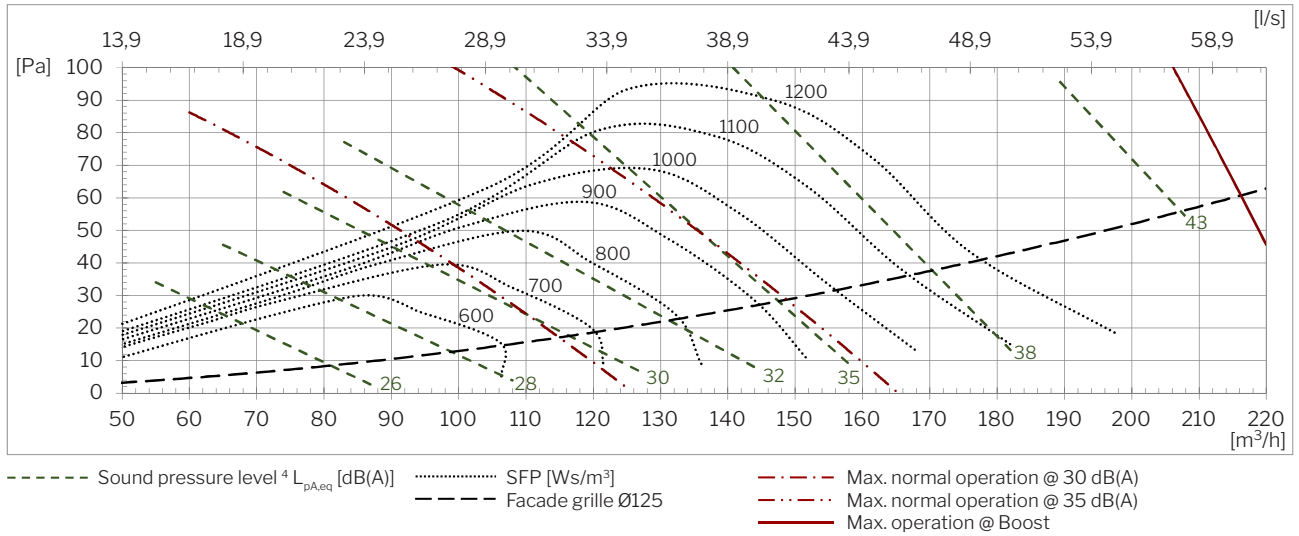

SFP with ePM₁ 55% / ePM₁₀ 50% filters

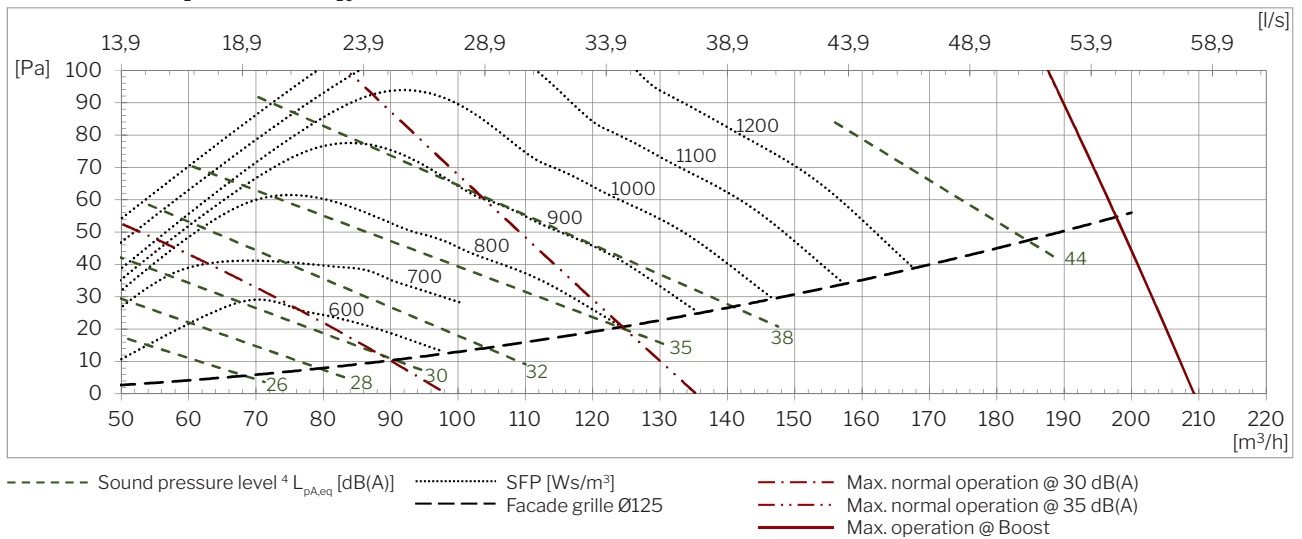

SEL med ePM₁ 80% / ePM₁₀ 50% filtre:

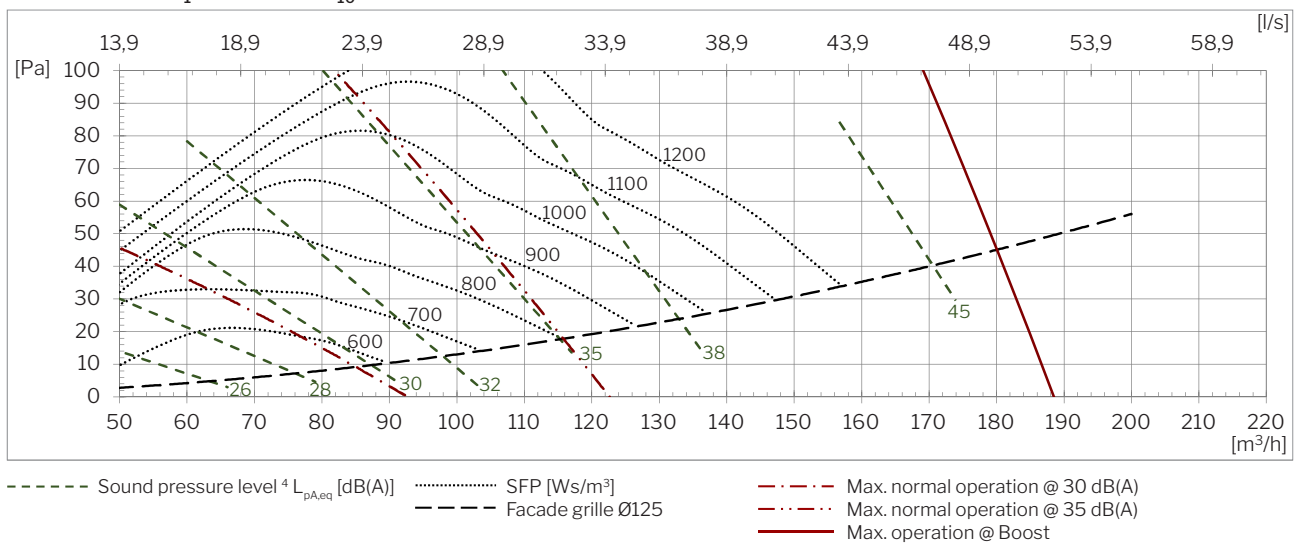

⁴ The sound pressure level L_{pA,eq} is measured at a height of 1,2 m at a horizontal distance of 1 m from the air handling unit.

Sound pressure level $L_{pA,eq}^5$ acc. to Airmaster reference situation

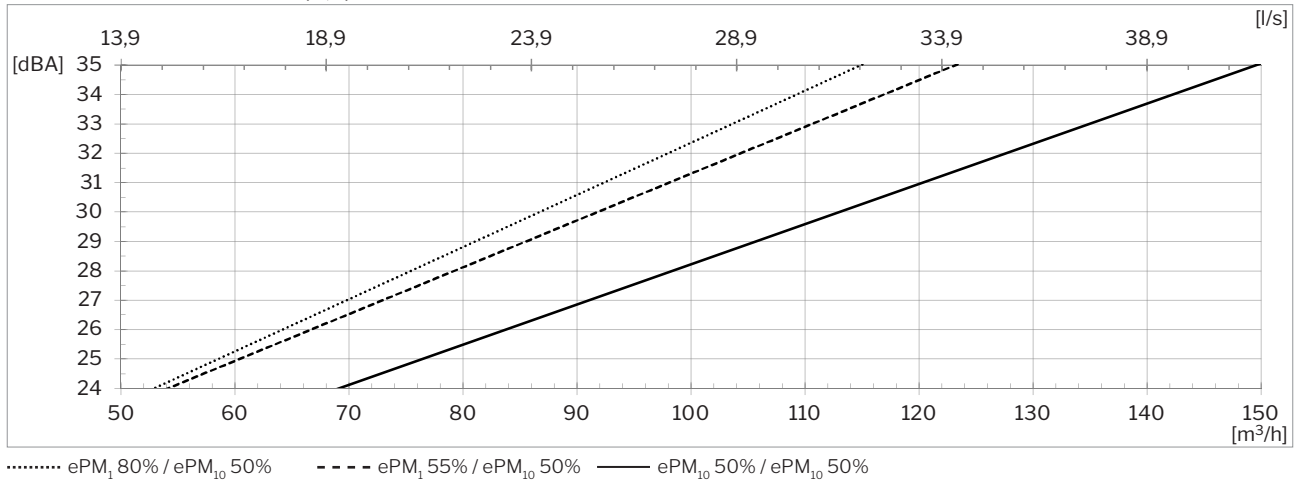

Temperature efficiency acc. to EN 308

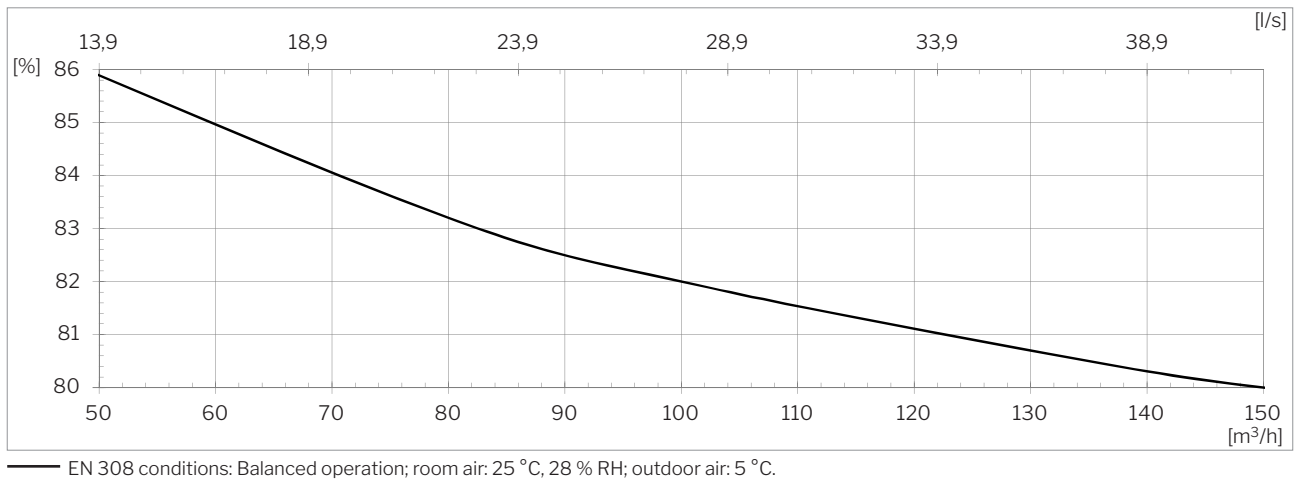

Power consumption

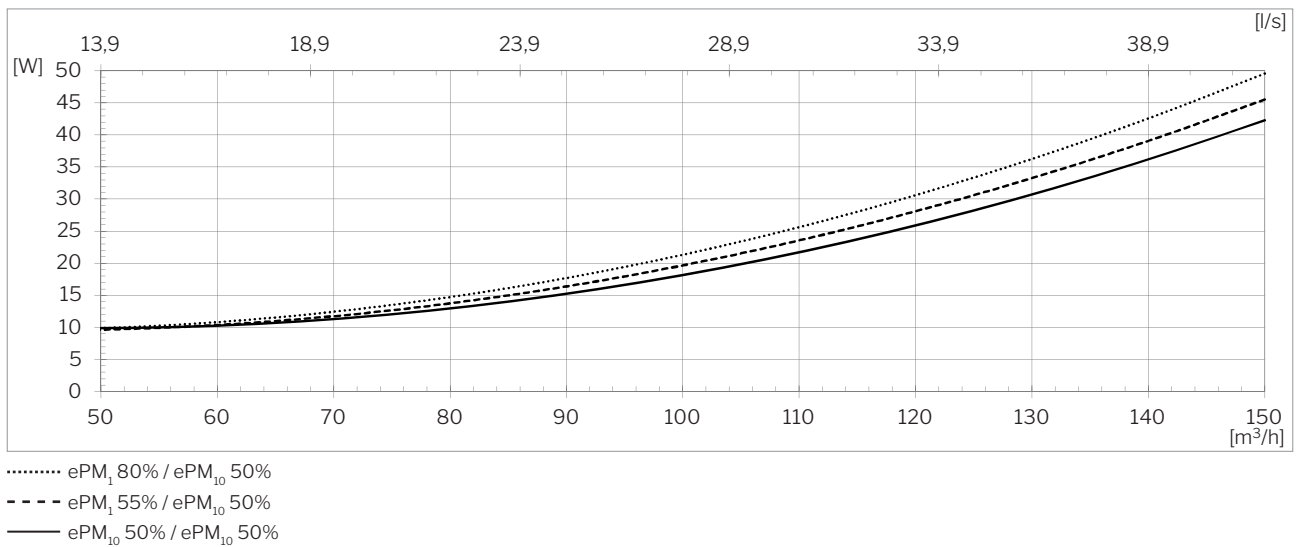

⁵ The sound pressure level $L_{pA,eq}$ is measured at a height of 1.2 m at a horizontal distance of 1 m from the air handling unit.

SFP⁶

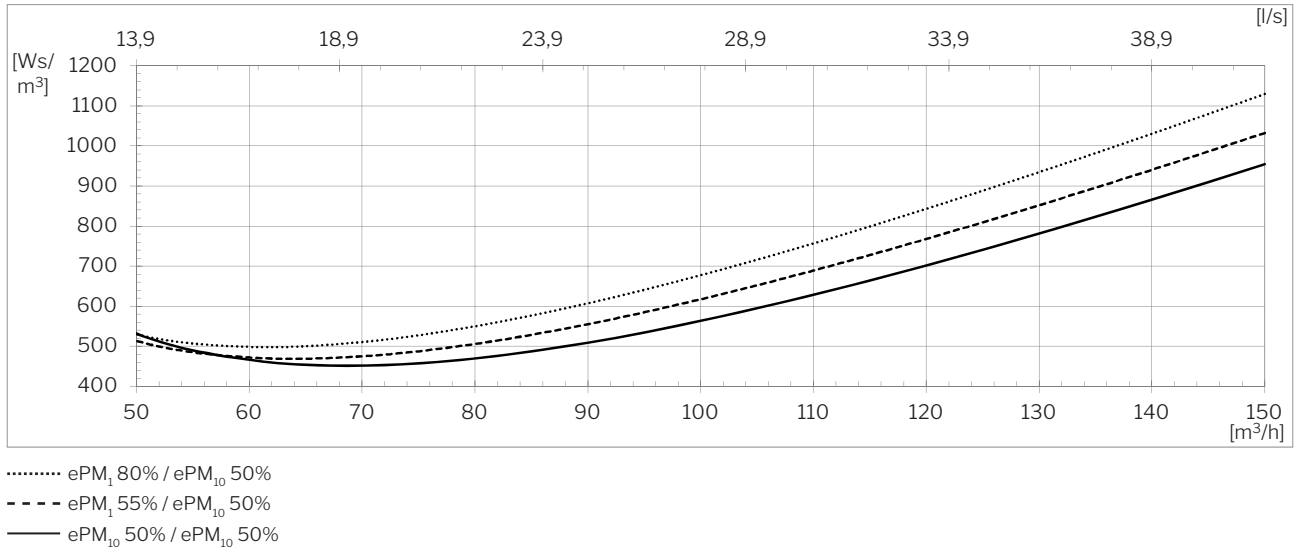

⁶ The calculation of SFP includes the power consumption for operating fans but not for controls, display panel, etc.

Throw ⁷ (0,2 m/s)

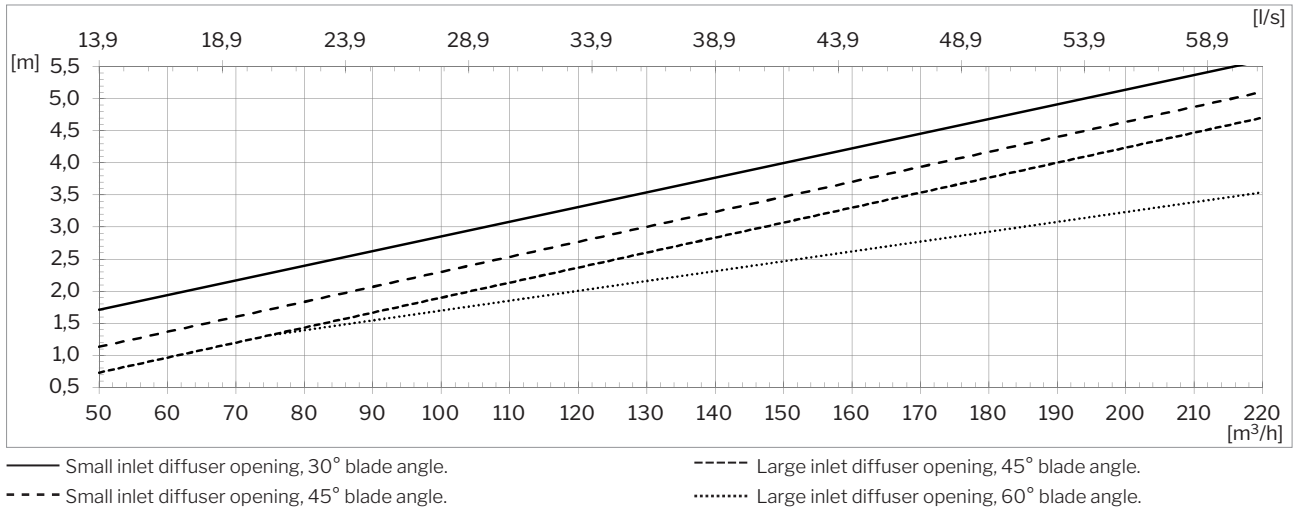

Small and large inlet diffuser opening

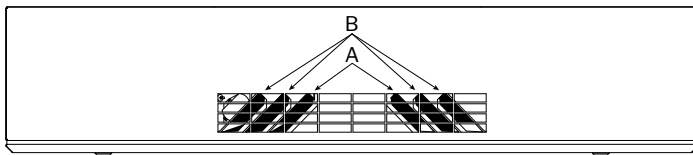

Small inlet diffuser opening:
A is closed, B is open at x° .

Large inlet diffuser opening:
A and B are open at x° .

Default delivery state:
Small inlet diffuser opening, 45° blade angle.

Throw and dispersion, top view.

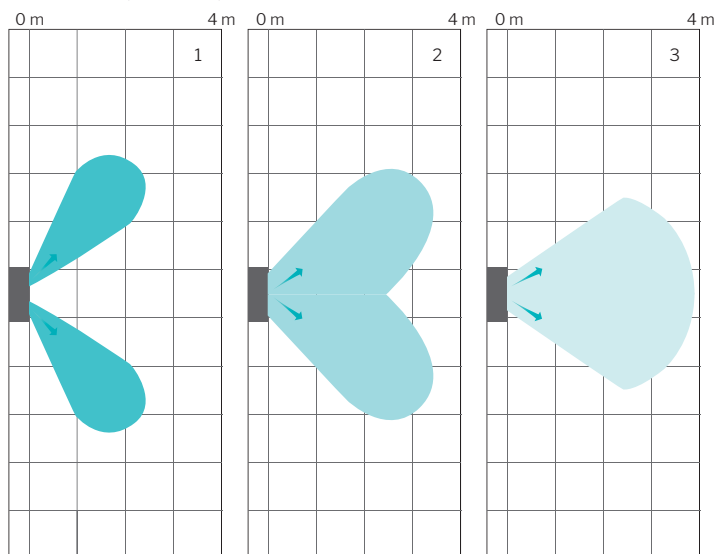

The air handling unit disperses inlet air depending on the blade angle settings.

The illustrations show the dispersion pattern and throw for the various blade angle settings at an air flow of 147 m³/h:

1. Large inlet diffuser opening, 60° blade angle.
2. Small inlet diffuser opening, 45° blade angle.
3. Small inlet diffuser opening, 30° blade angle.

Changing the air flow also affects the throw.

Throw, side view.

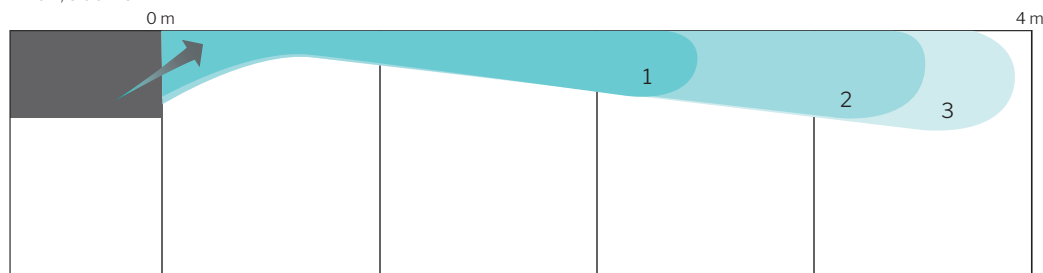

⁷ The throw is measured with a 2 °C subcooled inlet air supply.

Version overview AM 150

Exhaust/supply position
» Back (**H**orizontal)

Inlet/extract position
» Bottom (**B**)
» Ducted Inlet (**DI**)
» Ducted Extract (**DE**)

Mounting
» Wall/ceiling bracket
» Ceiling Frame (**CF**)

H BB

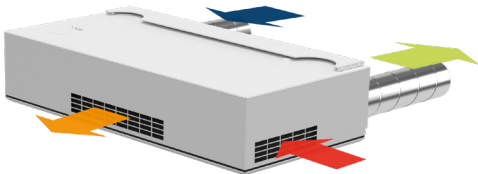

HL BDE - CF^{8,9}

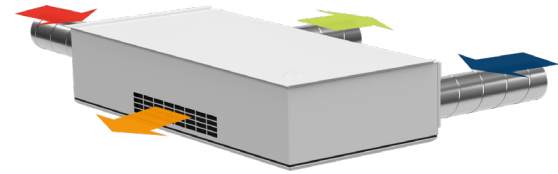

H BDE

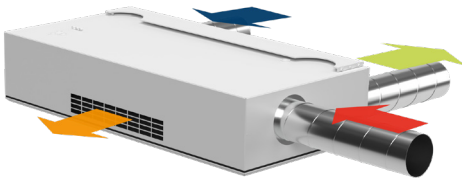

H DIB⁸

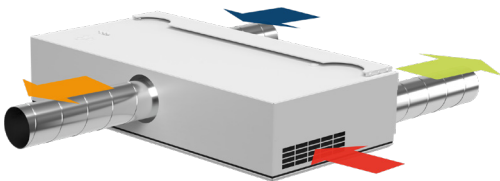

H DIDE⁸

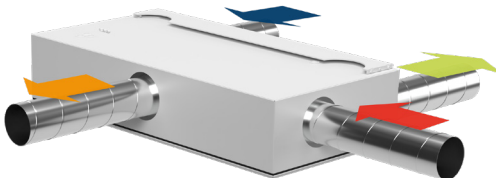

⁸ Special item
⁹ L: Left model

Standards and options

Counterflow heat exchanger (PET)	x
Enthalpy counterflow heat exchanger (polymer membrane)	o
Combination counterflow heat exchanger (polymer membrane)	o
Motor-driven bypass	x
Motor-driven supply air damper	x
Motor-driven extract air damper	x
Electric heating surface/VPH ¹⁰	•
Condensate pump	•
PIR/motion sensor (wall mounted)	•
PIR/motion sensor (integrated)	•
CO ₂ sensor (wall mounted)	•
CO ₂ sensor (integrated)	•
TVOC (integrated)	•
CO ₂ -/TVOC sensor (integrated)	•
Hygrostat (wall mounted)	o
Energy meter	•
Supply air filter ePM ₁₀ 50%	•

Supply air filter ePM ₁ 55%	•
Supply air filter ePM ₁ 80%	o
Extract air filter ePM ₁₀ 50%	x
LED (operating mode indicator)	x
Comfort cooling module	•
Wall/ceiling bracket	•
Ceiling frame	•
Operating button	•
Control panel, Viva	•
Control panel, Orbit	•
Airmaster Airlinq® Online	•
Airlinq® Online API	•
Airlinq® BMS	•
LON® module	o
KNX® module	o
MODBUS® RTU RS485 module	•
BACnet™ MS/TP module	•
BACnet™ /IP module	•

X : Standard • : Optional o : Special item (not stock item)

Schematic sketch

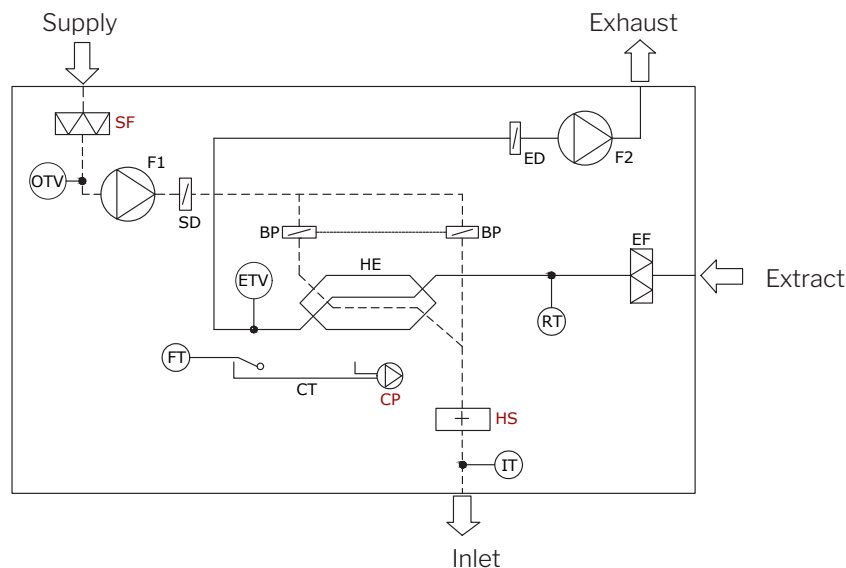

Component designation

BP	Bypass damper (motor-driven)	FT	Float	OTV	Temperature sensor, Supply air ventilation
CP	Condensate pump (option)	F1	Supply air fan	RT	Temperature sensor, Room
CT	Condensate tray	F2	Extract air fan	SD	Supply air damper (motor-driven)
ED	Exhaust air damper (motor-driven)	HE	Counterflow heat exchanger	SF	Supply air filter (option)
EF	Extract air filter	HS	Electric heating surface (option)		
ETV	Temperature sensor, Exhaust, Ventilation	IT	Temperature sensor, Inlet-air		

¹⁰ Virtual PreHeat