

## Datasheet AM 1200 V



Technical data	Filter class	30 dB(A)	33 dB(A)	35 dB(A)
Maximum capacity <sup>1</sup>	ePM <sub>10</sub> 50%	870 m <sup>3</sup> /h	1000 m <sup>3</sup> /h	1130 m <sup>3</sup> /h
Vertical model, right/left:	ePM <sub>1</sub> 55%	783 m <sup>3</sup> /h	900 m <sup>3</sup> /h	1017 m <sup>3</sup> /h
	ePM <sub>1</sub> 80%	696 m <sup>3</sup> /h	800 m <sup>3</sup> /h	904 m <sup>3</sup> /h
Maximum capacity <sup>1</sup>	ePM <sub>10</sub> 50%	980 m <sup>3</sup> /h	1120 m <sup>3</sup> /h	1260 m <sup>3</sup> /h
Vertical model, center:	ePM <sub>1</sub> 55%	882 m <sup>3</sup> /h	1008 m <sup>3</sup> /h	1134 m <sup>3</sup> /h
	ePM <sub>1</sub> 80%	784 m <sup>3</sup> /h	896 m <sup>3</sup> /h	1008 m <sup>3</sup> /h
Throw length (0.2 m/s) <sup>1</sup> - right/left	min.			4 m v. 1000 m <sup>3</sup> /h
	max.			9 m v. 1000 m <sup>3</sup> /h
	min.			5.5 m v. 1300 m <sup>3</sup> /h
	max.			11 m v. 1300 m <sup>3</sup> /h
Throw length (0.2 m/s) <sup>1</sup> - center:	min.			3 m v. 1000 m <sup>3</sup> /h
	max.			6.5 m v. 1000 m <sup>3</sup> /h
	min.			4 m v. 1300 m <sup>3</sup> /h
	max.			8 m v. 1300 m <sup>3</sup> /h
Supply air filter	ePM <sub>10</sub> 50%, ePM <sub>1</sub> 55% or ePM <sub>1</sub> 80%			
Extract air filter	ePM <sub>10</sub> 50%			
Dimensions (BxHxD)	Horizontal:	496 x 2098 x 2427 mm		
	Vertical:	496 x 2406 x 2427 mm		
Weight, including painted panels	Right-/left model:	545 kg		
	Center model:	630 kg		
Color casing	RAL 7024			
Counterflow heat exchanger	4 x Aluminum			
Air leakage classification cf. EN1886/EN13141-7	Class L2 / A2			
Air leakage classification main damper, cf. EN1751	Class 3			
IP code	10			
Duct connection	Ø400 mm			
Condensate pump (Capacity ; Lifting height at 5 l/h)	10 l/h ; 6 m			
Condensate drain hose int./ext. diameter	Ø4 mm / Ø6 mm			
Supply voltage	220-240V/50Hz, ~1N+PE			
	220-240V/50Hz, ~3N+PE			
Nominal power consumption <sup>1</sup>	254 W			
Nominal current <sup>1</sup>	1.4 A			
Power factor	0.6			
Maximum fuse	16 A (1 phase, type B)			
	3 x 16 A (3 phases, type B). When choosing a pre-heating surface, a 3-phase connection must be used			
Leakage current AC / DC	≤ 9 mA			
Recommended residual current breaker (RCCB)	Type B			

<sup>1</sup> All measurements were performed in normal operating mode in a standard installation using the facade grilles Ø400 recommended by Airmaster.

<sup>2</sup> The supply can be limited to a single-phase, connected to L1. Only for air handling units without electric heating surface.

<b>Electrical heating surfaces</b>	<b>Preheating surface</b>	<b>Comfort heating surface</b>
Heat output	2500 W	1670 W
Nominal current	10.9 A	7.3 A
Thermal circuit breaker, manual reset	100 °C	100 °C

<b>Water heating surface</b>	
Nominal heat output <sup>3</sup>	2454 W
Connection dimension	1/2" (DN 15)
Materials pipes/fins	Copper/aluminum
Opening/closing time motor valve	60 s
Maximum operating temperature	90 °C
Maximum operating pressure	5 bar

<sup>3</sup> Heat output for maximum capacity at 35 dB(A), delivery/return temperature 60/40°C and a liquid flow of 107 l/h.

## AM 1200 V - R/L

### Capacity with ePM<sub>10</sub> 50% / ePM<sub>10</sub> 50% filters <sup>4</sup>

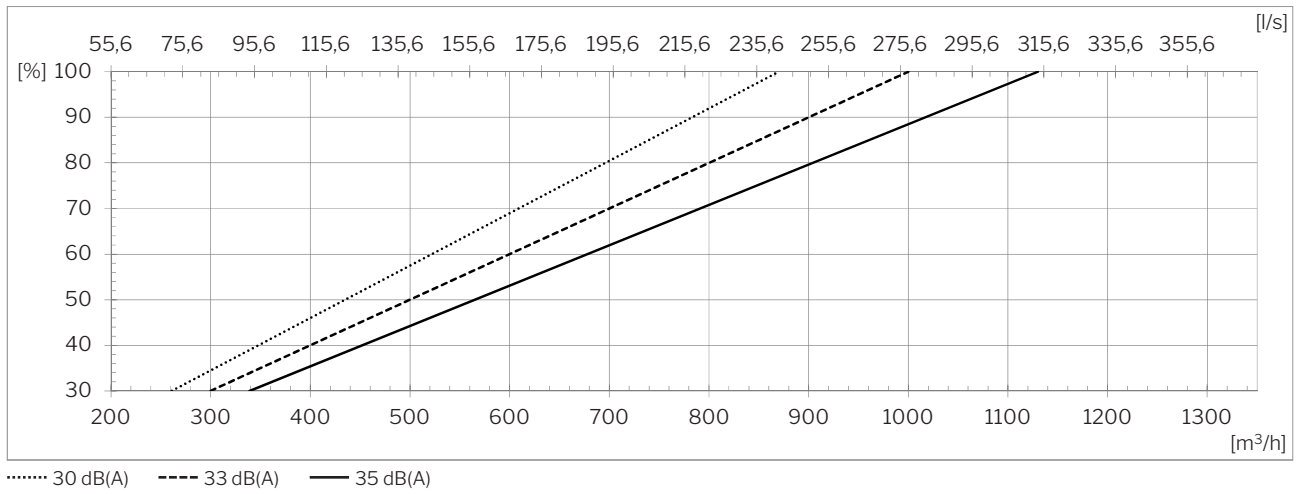

### Capacity with ePM<sub>1</sub> 55% / ePM<sub>10</sub> 50% filters <sup>4</sup>

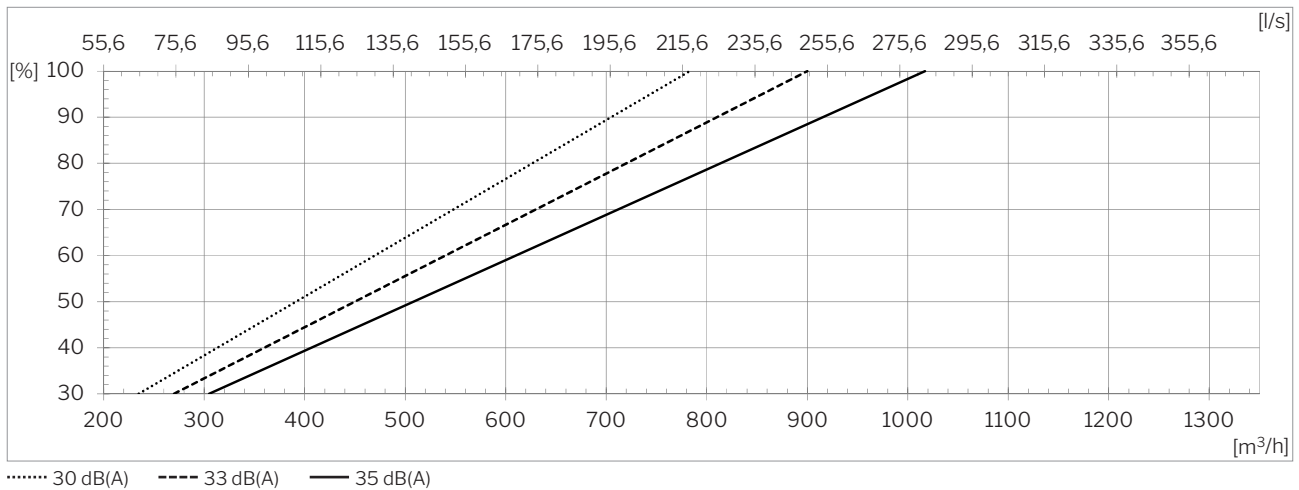

### Capacity with ePM<sub>1</sub> 80% / ePM<sub>10</sub> 50% filters <sup>4</sup>

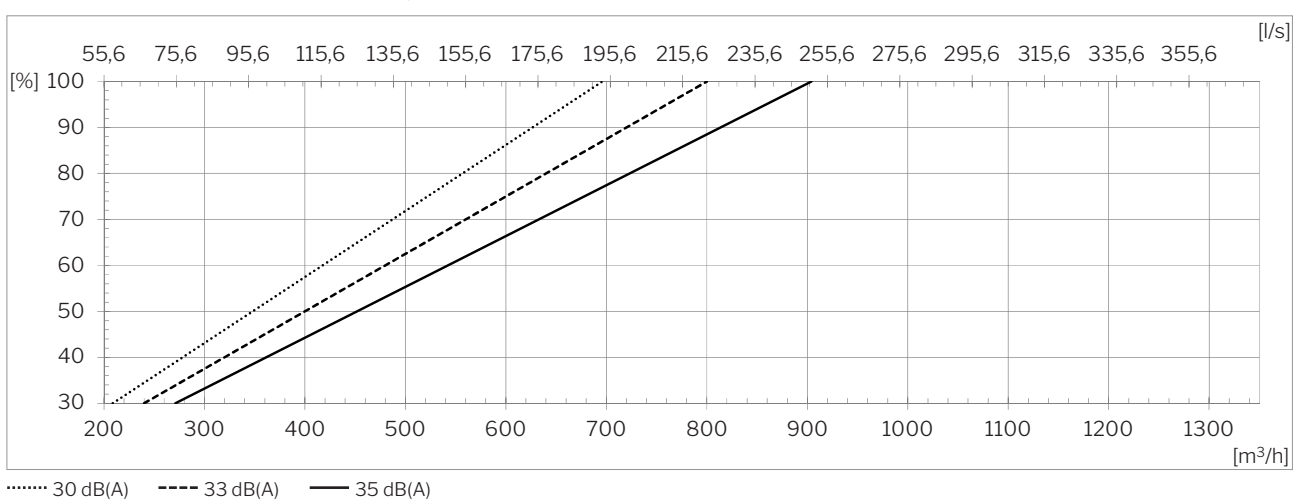

<sup>4</sup> All measurements were performed in normal operating mode in a standard installation using the facade grilles Ø400 recommended by Airmaster.

## AM1200 V - C

### Capacity with ePM<sub>10</sub> 50% / ePM<sub>10</sub> 50% filters <sup>5</sup>

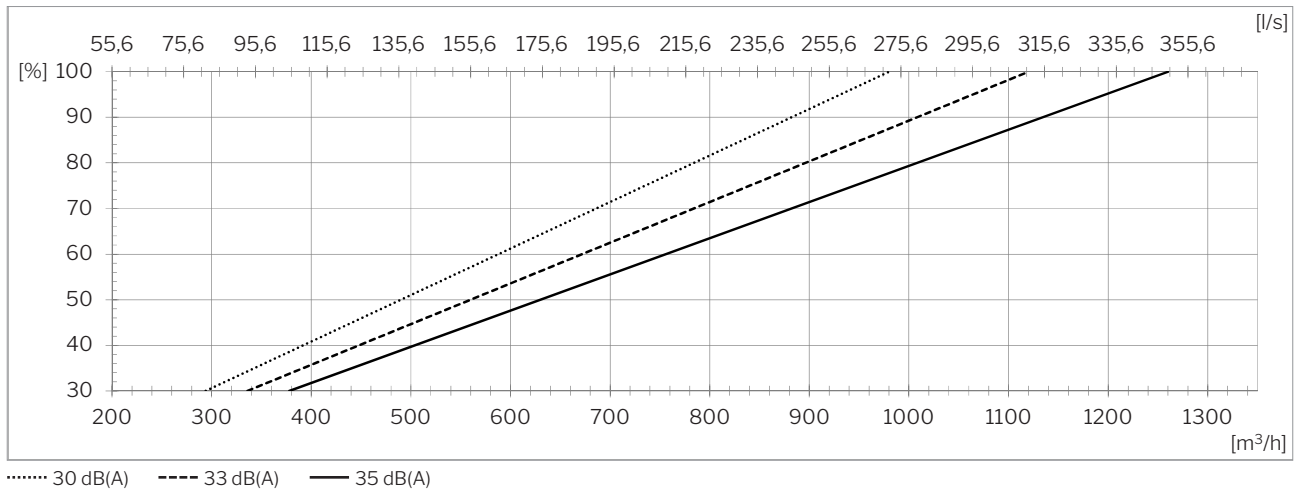

### Capacity with ePM<sub>1</sub> 55% / ePM<sub>10</sub> 50% filters <sup>5</sup>

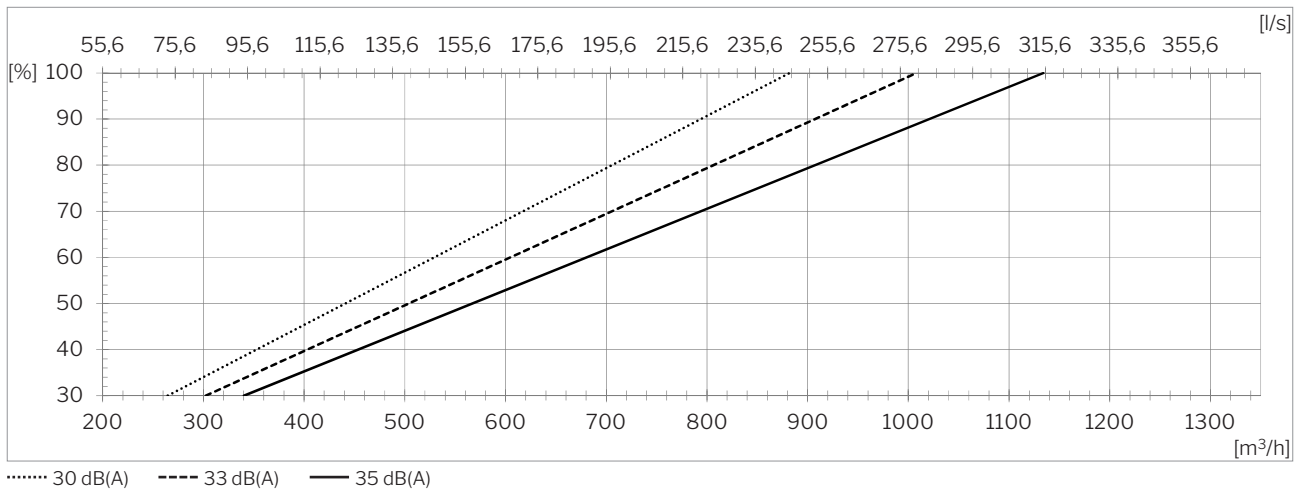

### Capacity with ePM<sub>1</sub> 80% / ePM<sub>10</sub> 50% filters <sup>5</sup>

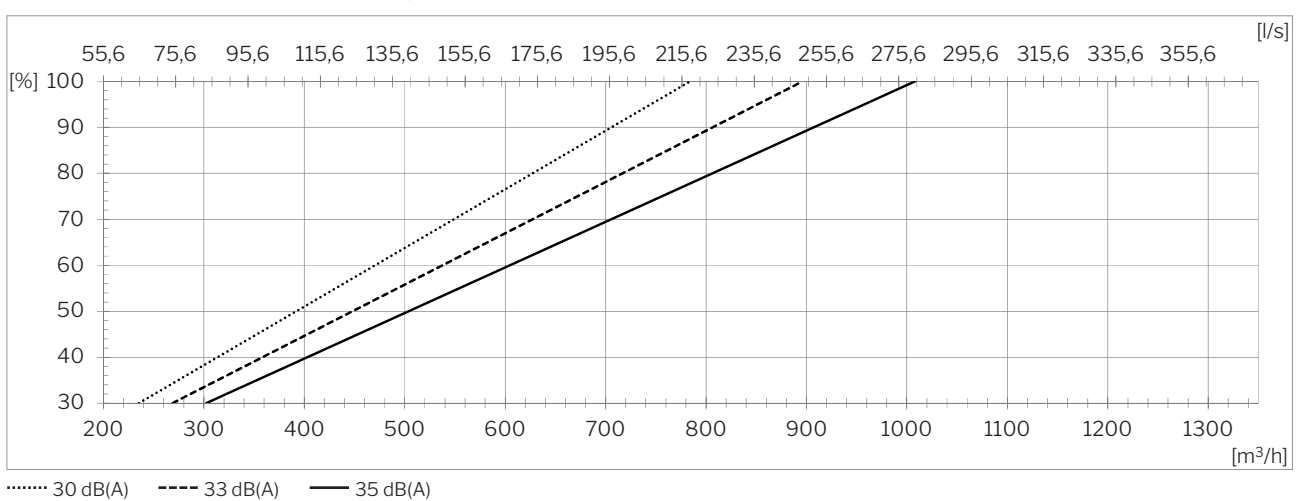

<sup>5</sup> All measurements were performed in normal operating mode in a standard installation using the facade grilles Ø400 recommended by Airmaster.

## Sound pressure <sup>6</sup>L<sub>pA,eq</sub> acc. Airmaster reference situation

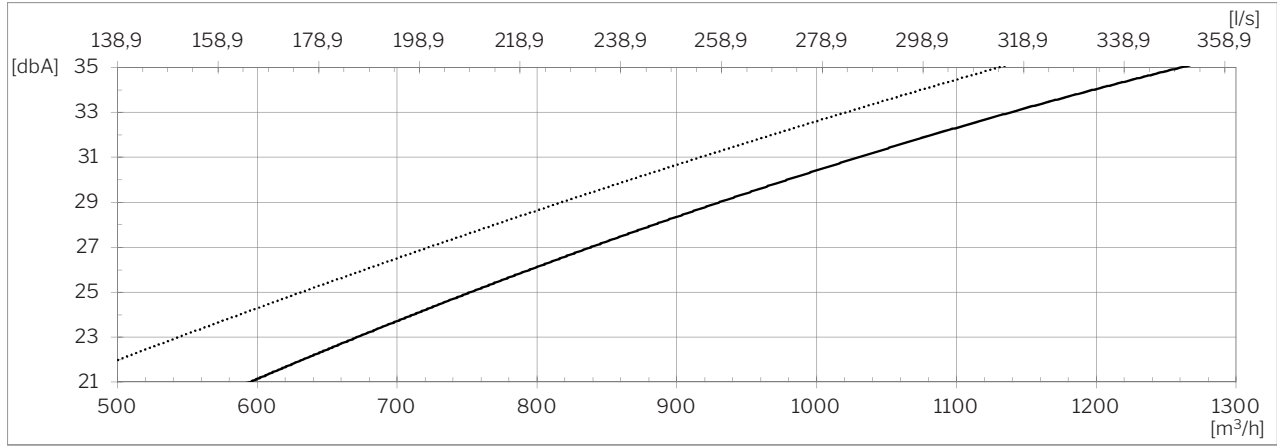

..... Right/left

— Center

## Temperature efficiency acc. EN 308

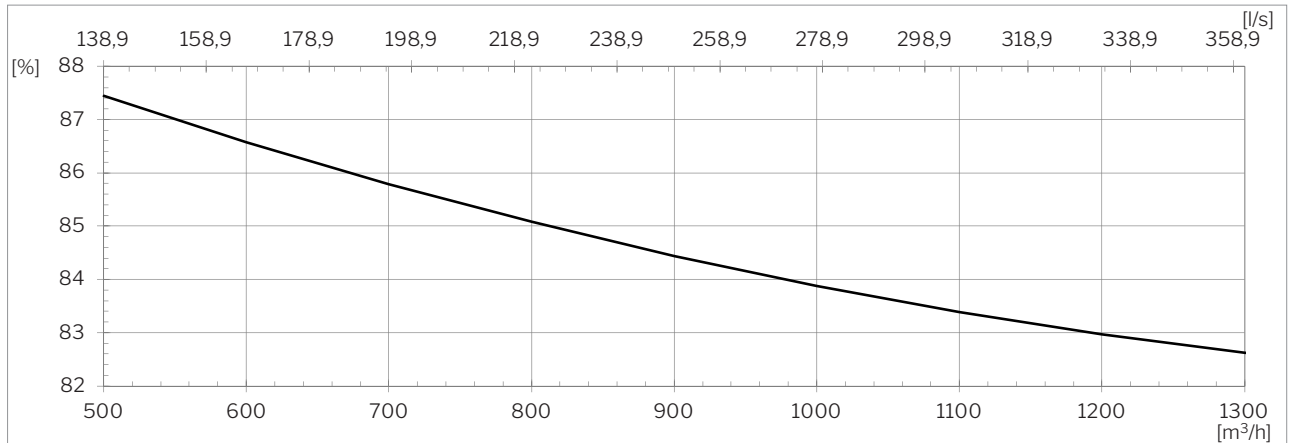

— Balanced airflow; Extraction: 25 °C, 28 % RH; Supply: 5 °C.

## Power consumption <sup>7</sup>

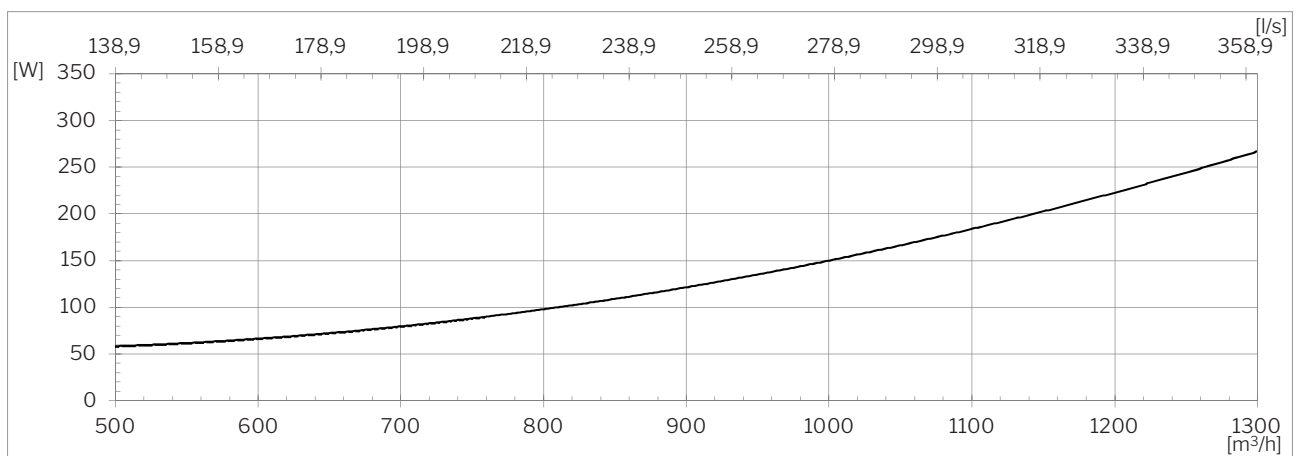

— ePM<sub>10</sub> 50% / ePM<sub>10</sub> 50%

<sup>6</sup> Sound pressure level L<sub>pA,eq</sub> is measured in a height of 1.2 m with at horizontal distance of 1 m from the air handling unit in room with a size of 200 m³ and a reverberation time of T = 0.6 s, corresponding to a room attenuation of 7.5 dB.

<sup>7</sup> All measurements were performed in normal operating mode in a standard installation using the facade grilles Ø400 recommended by Airmaster.

## SFP<sup>8</sup>

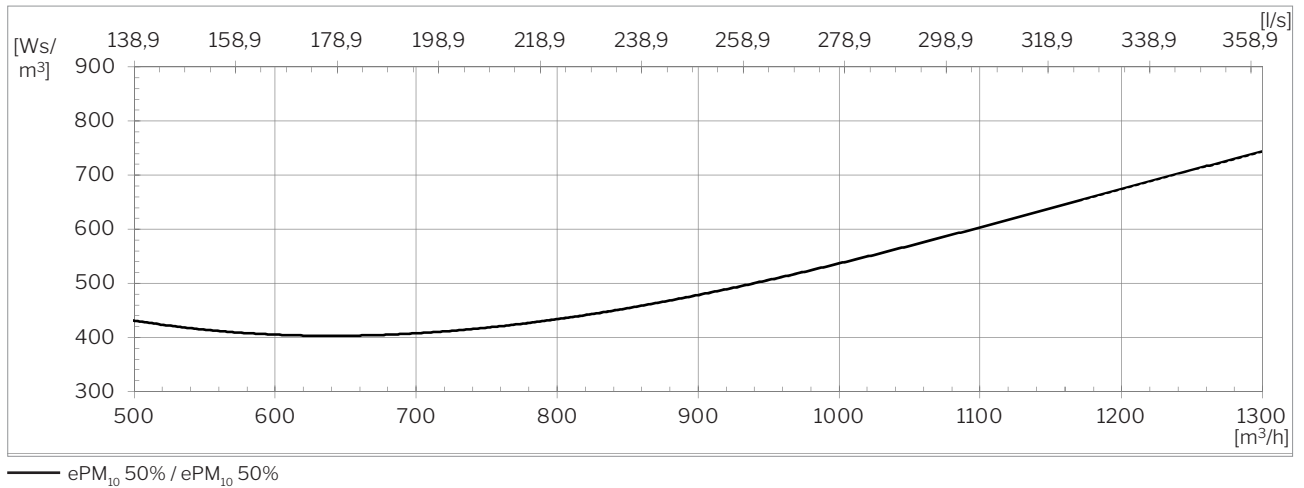

## External pressure loss - Supply air<sup>8</sup>

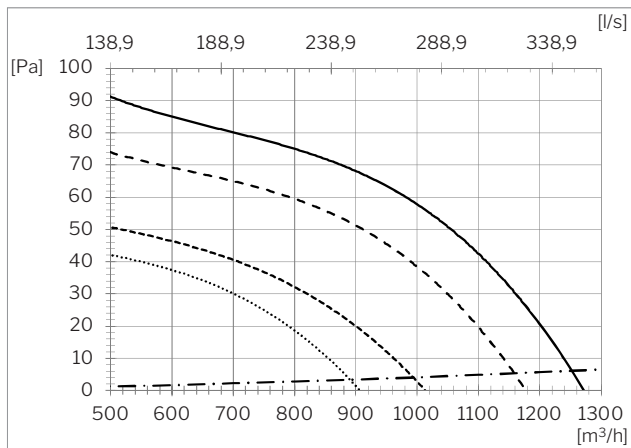

- Center, 35 dB(A), ePM10 50% filter
- - - - Right/left, 35 dB(A), ePM10 50% filter
- · - · - Center, 30 dB(A), ePM10 50% filter
- Right/left, 30 dB(A), ePM10 50% filter
- · - · - Recommended roof caps Ø400

## External pressure loss - Extract air<sup>8</sup>

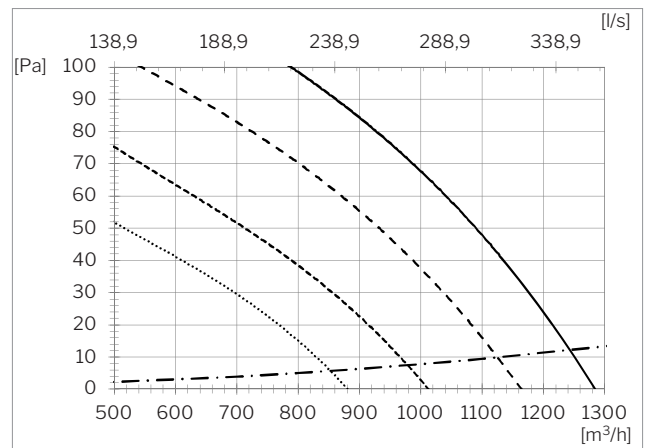

- Center, 35 dB(A), ePM10 50% filter
- - - - Right/left, 35 dB(A), ePM10 50% filter
- · - · - Center, 30 dB(A), ePM10 50% filter
- Right/left, 30 dB(A), ePM10 50% filter
- · - · - Recommended roof caps Ø400

<sup>8</sup> All measurements were performed in normal operating mode in a standard installation using the facade grilles Ø400 recommended by Airmaster.

## Throw length (0.2 m/s)

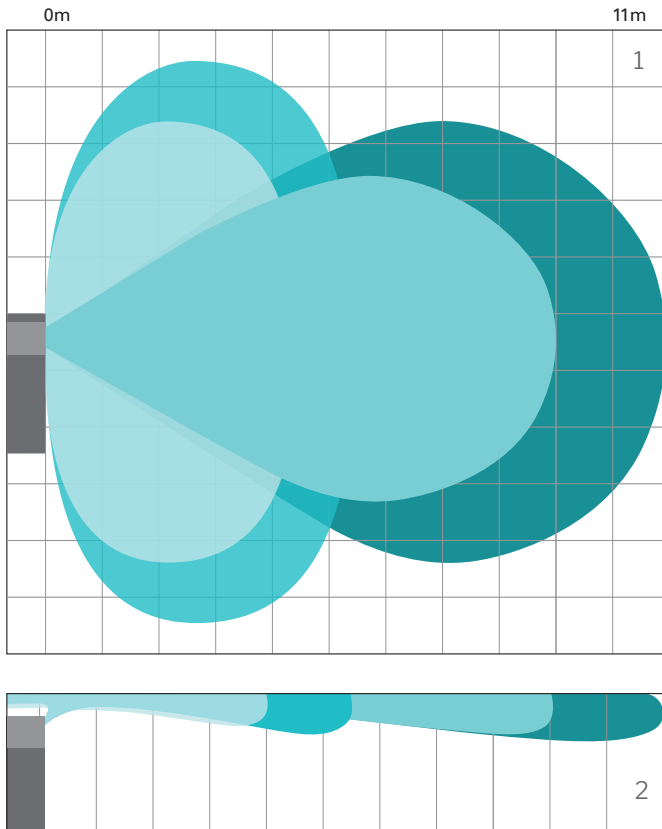

### 1300 m<sup>3</sup>/h

- Max.
- Min.

### 1000 m<sup>3</sup>/h

- Max.
- Min.

The AM 1200 unit spreads an air stream in different directions, depending on the given airflow.

This can be seen in the illustration, in which the blue shading indicates throw length the different airflows.

<sup>1</sup>Throw length seen from above.

<sup>2</sup>Throw length seen from the side.

## Variants

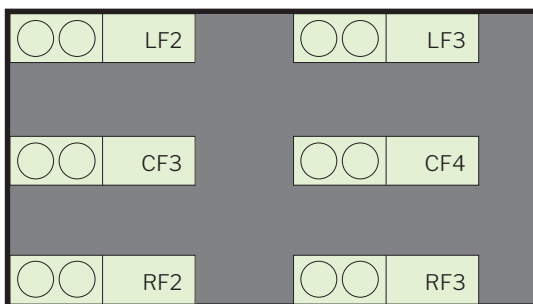

- AM 1200 VRF2 (right, with 2 open sides)
- AM 1200 VRF3 (right, with 3 open sides)
- AM 1200 VCF3 (centre, with 3 open sides)
- AM 1200 VCF4 (centre, with 4 open sides)
- AM 1200 VLF2 (left, with 2 open sides)
- AM 1200 VLF3 (left, with 3 open sides)

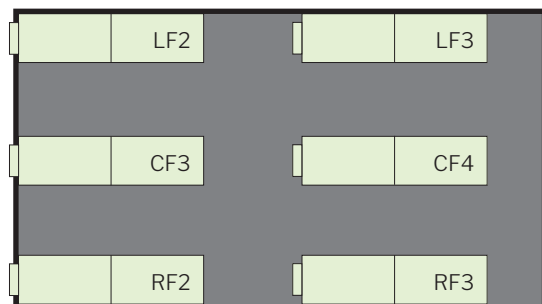

- AM 1200 HRF2 (right, with 2 open sides)
- AM 1200 HRF3 (right, with 3 open sides)
- AM 1200 HCF3 (centre, with 3 open sides)
- AM 1200 HCF4 (centre, with 4 open sides)
- AM 1200 HLF2 (left, with 2 open sides)
- AM 1200 HLF3 (left, with 3 open sides)

## Standard and options

Counterflow heat exchanger (aluminum)	x
Enthalpy counterflow heat exchanger (Polymer membrane)	o
Combination counterflow heat exchanger (Polymer membrane)	o
Motor-driven bypass	x
Sprint-return motor driven exhaust air damper	x
Spring-return motor driven supply air damper	x
Electric preheating surface	•
Electric comfort heating surface	•
Water heating surface	•
Condensate pump	•
PIR/motion sensor (wall-mounted)	•
CO <sub>2</sub> -sensor (wall-mounted)	•
CO <sub>2</sub> -sensor (built-in)	•
TVOC-sensor (built-in)	•
CO <sub>2</sub> -/TVOC-sensor (built-in)	•
Hygostat (wall-mounted)	o

Energy meter	•
Supply air filter ePM <sub>10</sub> 50%	•
Supply air filter ePM <sub>1</sub> 55%	•
Supply air filter ePM <sub>1</sub> 80%	o
Extract air filter ePM <sub>10</sub> 50%	x
Airlinq Viva control panel	•
Airlinq Orbit control panel	•
Airmaster Airlinq® Online	•
Airlinq® Online API	•
Airlinq® BMS	•
LON® module	o
KNX® module	o
MODBUS® RTU RS485 module	•
BACnet™ MS/TP module	•
BACnet™ /IP module	•

X : Standard    • : Optional    o : Special item (not stock item)

## Schematic sketch

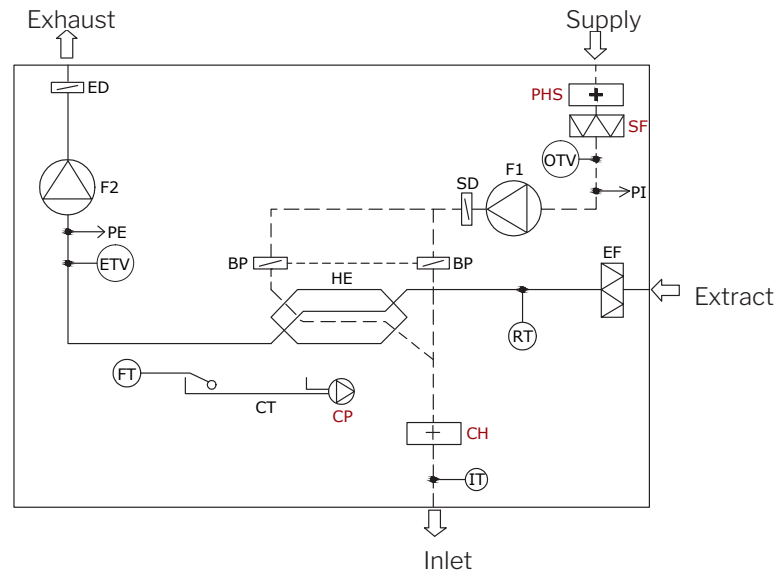

### COMPONENT DESIGNATION

BP	Bypass damper (motor-driven)
CH	Electric comfort heating surface (option)
CP	Condensate pump (option)
CT	Condensate tray
ED	Exhaust air damper (motor-driven)

EF	Extract air filter
ETV	Exhaust temperature sensor
FT	Float
F1	Supply air fan
F2	Extract air fan
HE	Counterflow heat exchanger
IT	Inlet-air temperature sensor

OTV	Supply air temperature sensor
PE	Flow meter, extracted air
PHS	Preheating surface (option)
PI	Flow meter, supply air
RT	Room temperature sensor
SD	Supply air damper (Motor-driven)
SF	Supply air filter (option)